



# **MX2800 M13 Multiplexer User Manual**

**Manual Part Number - 61200290L1-1G**

- 4205290L1 AC Non-Redundant Version with Modem
- 4205290L2 AC Redundant Version with Modem
- 4205290L3 DC Non-Redundant Version with Modem
- 4205290L4 DC Redundant Version with Modem
- 4205290L5 AC Non-Redundant Version
- 4205290L6 AC Redundant Version
- 4205290L7 DC Non-Redundant Version
- 4205290L8 DC Redundant Version
- 1205288L1 Controller Card
- 1205288L2 Controller Card
- 1200291L1 Breakout Panel
- 4175043L2 Battery Backup
- 1200657L2 Battery Backup Adapter Cable
- 1200287L1 Amp to Punch-Down Cable 25 ft.
- 1200287L5 Amp to Punch-Down Cable 50 ft.
- 1200287L7 Amp to Punch-Down Cable 100 ft.
- 1200291L5 BNC patch panel
- 1200466L1 Fan Faceplate

## Trademarks

Any brand names and product names included in this manual are trademarks, registered trademarks, or trade names of their respective holders.

OpenView™ is a trademark of Hewlett-Packard Company.

Spectrum® is a registered trademark of Cabletron.

ADVISION™ is a trademark of ADTRAN.

Total Access Element Management System™ is a trademark of ADTRAN.

## To the Holder of the Manual

The contents of this manual are current as of the date of publication. ADTRAN® reserves the right to change the contents without prior notice.

In no event will ADTRAN be liable for any special, incidental, or consequential damages or for commercial losses even if ADTRAN has been advised thereof as a result of issue of this publication.



901 Explorer Boulevard  
P.O. Box 140000  
Huntsville, AL 35814-4000  
(256) 963-8000

©2004 ADTRAN, Inc.  
All Rights Reserved.  
Printed in U.S.A.

---

## Revision History

Document Revision	Date	Description of Changes
G	Oct. 2004	This revision of the <i>MX2800 M13 Multiplexer User Manual</i> has been updated to include new features for the System Control Unit (P/N 1185002L2).

## Conventions

The following typographical conventions are used in this document:

[This font](#) indicates a cross-reference link. First-time references to tables and figures are shown in **this font**.

This font indicates screen menus, fields, and parameters.

THIS FONT indicates keyboard keys (ENTER, ESC, ALT). Keys that are to be pressed simultaneously are shown with a plus sign (ALT+X indicates that the ALT key and x key should be pressed at the same time).

*This font* indicates references to other documentation, sections of documents, and is also used for emphasis.

This font indicates on-screen messages and prompts.

**This font** indicates text to be typed exactly as shown.

**This font** indicates silkscreen labels or other system label items.

**This font** is used for strong emphasis

---

### NOTE

Notes inform the user of additional but essential information or features.

---

---

### CAUTION

Cautions inform the user of potential damage, malfunction, or disruption to equipment, software, or environment.

---

---

### WARNING

Warnings inform the user of potential bodily pain, injury, or death.

---

## FCC Radio Frequency Interference Statement

This equipment has been tested and found to comply with the limits for a Class A digital device, pursuant to Part 15 of the FCC Rules. These limits are designed to provide reasonable protection against harmful interference when the equipment is operated in a commercial environment. This equipment generates, uses, and can radiate radio frequency energy and, if not installed and used in accordance with the instruction manual, may cause harmful interference to radio frequencies. Operation of this equipment in a residential area is likely to cause harmful interference in which case the user will be required to correct the interference at his own expense.

---

### NOTE

Shielded cables must be used with this unit to ensure compliance with Class A FCC limits.

---

---

### CAUTION

Changes or modifications to this unit not expressly approved by the party responsible for compliance could void the user's authority to operate the equipment.

---

## Canadian Emissions Requirements

This digital apparatus does not exceed the Class A limits for radio noise emissions from digital apparatus as set out in the interference-causing equipment standard entitled "Digital Apparatus," ICES-003 of the Department of Communications.

Cet appareil numérique respecte les limites de bruits radioélectriques applicables aux appareils numériques de Class A prescrites dans la norme sur le matériel brouilleur: "Appareils Numériques," NMB-003 édictée par le ministre des Communications.

## Canadian Equipment Limitations

Notice: The Canadian Industry and Science Canada label identifies certified equipment. This certification means that the equipment meets certain telecommunications network protective, operational, and safety requirements. The Department does not guarantee the equipment will operate to the user's satisfaction.

Before installing this equipment, users should ensure that it is permissible to be connected to the facilities of the local telecommunications company. The equipment must also be installed using an acceptable method of connection. In some cases, the company's inside wiring associated with a single line individual service may be extended by means of a certified connector assembly (telephone extension cord). The customer should be aware that compliance with the above limitations may not prevent degradation of service in some situations.

Repairs to certified equipment should be made by an authorized Canadian maintenance facility designated by the supplier. Any repairs or alterations made by the user to this equipment, or equipment malfunctions, may give the telecommunications company cause to request the user to disconnect the equipment.

Users should ensure for their own protection that the electrical ground connections of the power utility, telephone lines and internal metallic water pipe system, if present, are connected together. This precaution may be particularly important in rural areas.

---

**CAUTION**

Users should not attempt to make such connections themselves, but should contract the appropriate electric inspection authority or an electrician, as appropriate.

---

The Load Number (LN) assigned to each terminal device denotes the percentage of the total load to be connected to a telephone loop which is used by the device, to prevent overloading. The termination on a loop may consist of any combination of devices subject only to the requirement that the total of the Load Numbers of all devices does not exceed 100.

## Training

ADTRAN offers product training. The training courses include overviews on product features and functions while covering applications of ADTRAN's product lines. ADTRAN provides a variety of training options, including customized training and course taught at our facilities or at customer sites. For more information about training, please contact us.

Training Phone: 800-615-1176, ext. 7500

Training Fax: 256-963-6700

Training Email: [training@adtran.com](mailto:training@adtran.com)

This page is intentionally blank.

# MX2800 M13 Multiplexer User Manual

## Contents

<b>Section 1</b>	
<b>Product Overview</b> .....	<b>1-1</b>
<b>1. Introduction</b> .....	<b>1-1</b>
<b>2. Controller Card 1:1 Redundancy</b> .....	<b>1-2</b>
<b>3. T3 Overview</b> .....	<b>1-2</b>
<b>4. SNMP</b> .....	<b>1-2</b>
Network Manager .....	1-2
Agent .....	1-3
MIB .....	1-3
<b>5. Telnet</b> .....	<b>1-3</b>
<b>6. TL1</b> .....	<b>1-3</b>
<b>7. Available Options</b> .....	<b>1-3</b>
Breakout Panel (P/N 1200291L1) .....	1-3
E1 Patch Panel (P/N 1200291L5) .....	1-3
Battery Backup (P/N 4175043L2) .....	1-4
Fan Faceplate (P/N 1200466L1) .....	1-4
<b>Section 2</b>	
<b>Installation and Operation</b> .....	<b>2-1</b>
<b>1. Introduction</b> .....	<b>2-1</b>
<b>2. Receiving Inspection</b> .....	<b>2-1</b>
<b>3. ADTRAN Shipping Contents</b> .....	<b>2-1</b>
<b>4. Power Up</b> .....	<b>2-2</b>
<b>5. Rackmount Installation</b> .....	<b>2-4</b>
Connecting the Breakout Panel .....	2-5
Connecting the E1 Patch Panel .....	2-5
<b>6. Rear Panel</b> .....	<b>2-6</b>
LAN Port .....	2-7
Modem Port .....	2-7
Noncritical and Critical Alarm Connectors .....	2-7
DSX-3 Interfaces .....	2-7
DSX-1/E1 Interfaces .....	2-8
Power Connection .....	2-8
<b>7. Front Panel</b> .....	<b>2-8</b>

Craft Port .....	2-8
Establishing Terminal Connection .....	2-9
Main Menu .....	2-9
Navigating Within the Menus .....	2-10
Status .....	2-11
Statistics .....	2-11
Configuration .....	2-12
Loopbacks .....	2-13
Telnet Client .....	2-13
Logout .....	2-15
Privilege Level .....	2-15
ACO Buttons .....	2-15
LED Descriptions .....	2-15
Power Supply A/B Status LEDs .....	2-15
Controller Cards Status LEDs .....	2-15
T1/E1 Status LEDs .....	2-17
<b>8. Replacing or Installing Cards .....</b>	<b>2-18</b>
<b>Section 3</b>	
<b>Configuration .....</b>	<b>3-1</b>
<b>1. Introduction .....</b>	<b>3-1</b>
<b>2. Network Interface .....</b>	<b>3-4</b>
DS3 Configuration .....	3-4
Framing .....	3-4
Line Length .....	3-4
Timing .....	3-5
Remote Loopbacks .....	3-5
XCV Threshold .....	3-6
Protection Configuration .....	3-6
Active Controller .....	3-6
Network Protection .....	3-6
Maximum Switch Threshold .....	3-6
Min. Switching Period .....	3-6
Miscellaneous .....	3-7
Loopback Timeout .....	3-7
Shutdown Stand-By .....	3-7
DS2 Configuration .....	3-7
<b>3. T1/E1 Interface .....</b>	<b>3-8</b>
T1/E1 State .....	3-9
Set Multiple .....	3-9
T1/E1 Line Coding .....	3-10
T1/E1 Line Length .....	3-11
T1/E1 Loopback Detection .....	3-12
T1/E1 Circuit Protection .....	3-13
T1/E1 Line Identification .....	3-14
XCV Threshold .....	3-15
<b>4. System Management .....</b>	<b>3-16</b>
Management Options .....	3-17



---

Local IP Address . . . . .	3-17
Gateway IP Address . . . . .	3-17
Subnet Mask . . . . .	3-17
Modem Remote IP Address . . . . .	3-17
Management Port . . . . .	3-17
Forward IP to Remote DS3 . . . . .	3-17
DS3 Remote IP Address . . . . .	3-18
DS3 IP MTU . . . . .	3-18
Dialup Options . . . . .	3-18
Primary and Secondary Phone Numbers . . . . .	3-19
Initializing String . . . . .	3-19
Dial String . . . . .	3-19
Maximum Redial Attempts . . . . .	3-19
Idle Timeout . . . . .	3-19
Connection Timeout . . . . .	3-20
Pause Between Calls . . . . .	3-20
Dialout On Trap . . . . .	3-20
Answer on Ring . . . . .	3-20
Modem Mode . . . . .	3-20
Modem Baud Rate . . . . .	3-20
Hangup . . . . .	3-21
Last Modem Response . . . . .	3-21
SNMP Management Options . . . . .	3-21
SNMP State . . . . .	3-21
Trap IP Addresses . . . . .	3-21
Trap Generation . . . . .	3-21
Read Community Name . . . . .	3-24
Write Community Name . . . . .	3-25
Trap Community Name . . . . .	3-25
System Name . . . . .	3-25
Network Date/Time Option . . . . .	3-25
State . . . . .	3-25
Server IP Address . . . . .	3-25
Refresh Period . . . . .	3-25
DST Automatic Adjustment . . . . .	3-26
Local Time Zone . . . . .	3-26
System Security . . . . .	3-26
User Account Management . . . . .	3-26
Guest . . . . .	3-26
Interface . . . . .	3-26
Test . . . . .	3-27
Admin . . . . .	3-27
RADIUS Authentication . . . . .	3-27
RADIUS State . . . . .	3-27
Server IP Address . . . . .	3-28
UDP Port . . . . .	3-28
Privilege Level . . . . .	3-28
Shared Secret Visibility . . . . .	3-28
Shared Secret . . . . .	3-29
Response Timeout . . . . .	3-29
Maximum Retries . . . . .	3-29
Terminal Time Out . . . . .	3-33

---

IP Security .....	3-33
IP Hosts .....	3-33
Date and Time .....	3-33
Miscellaneous .....	3-33
Alarm Relay Configuration .....	3-33
Equipment Identification .....	3-35
Unit ID .....	3-36
Facility ID .....	3-36
Location ID .....	3-36
Frame ID .....	3-36
Unit Code .....	3-36
Equipment Codes .....	3-37
Syslog Setup .....	3-37
Transmission .....	3-37
Host IP Address .....	3-37
Severity Level .....	3-37
Host Facility .....	3-37
Auto Save .....	3-38
Craft Baud Rate .....	3-38
<b>5. Utilities .....</b>	<b>3-38</b>
Loading Default Settings .....	3-39
Load Default Settings Other Than System Management .....	3-39
Load System Management Default Settings .....	3-39
Load All Default Settings .....	3-40
Updating Software .....	3-40
Update Via XModem .....	3-40
Configuration Transfer .....	3-42
Saving to a TFTP Server .....	3-42
Retrieving from a TFTP Server .....	3-43
Resetting the System .....	3-43
<b>6. Save Configuration and Alarm Log .....</b>	<b>3-44</b>
<b>Section 4</b>	
<b>Status .....</b>	<b>4-1</b>
<b>1. Introduction .....</b>	<b>4-1</b>
<b>2. DS3 State .....</b>	<b>4-1</b>
Rx Framing .....	4-1
State .....	4-2
Alarm .....	4-2
Remote .....	4-3
<b>3. Power Supply State .....</b>	<b>4-4</b>
<b>4. System State .....</b>	<b>4-4</b>
Alarm .....	4-4
Protection .....	4-5
Card Comm .....	4-5
<b>5. DS2 State .....</b>	<b>4-6</b>
<b>6. T1/E1 State .....</b>	<b>4-6</b>

<b>7. Acknowledge Alarms (ACO)</b> .....	<b>4-6</b>
<b>Section 5</b>	
<b>Statistics</b> .....	<b>5-1</b>
<b>1. Introduction</b> .....	<b>5-1</b>
<b>2. Viewing Statistical Information</b> .....	<b>5-1</b>
DS3 Statistics .....	5-2
24 Hour Alarm History .....	5-2
Performance Parameters .....	5-4
Interval starting at: .....	5-7
Unavailable Seconds (UAS) .....	5-8
Severely Errored Framing Seconds (SEFS) .....	5-8
Line Coding Violation (LCV) .....	5-8
Line Errored Seconds (LES) .....	5-8
P-Bit Errored Seconds (PES) .....	5-8
P-Bit Severely Errored Seconds (PSES) .....	5-8
P-Bit Coding Violations (PCV) .....	5-8
C-Bit Code Violations (CCV) .....	5-8
C-Bit Errored Seconds (CES) .....	5-8
C-Bit Severely Errored Seconds (CSES) .....	5-8
F-Bit Errors (FBE) .....	5-8
Far End Block Error (FEBE) .....	5-9
Clear All Local DS3 Statistics/Refresh All Remote Statistics .....	5-9
DS2 Statistics .....	5-9
24-Hour Alarm History .....	5-9
Performance Parameters .....	5-11
T1/E1 Statistics .....	5-13
<b>3. Protection Switch Statistics</b> .....	<b>5-14</b>
Performance Parameters .....	5-14
Alarm Log .....	5-14
<b>Section 6</b>	
<b>Loopbacks</b> .....	<b>6-1</b>
<b>1. Introduction</b> .....	<b>6-1</b>
<b>2. T1/E1 Loopbacks</b> .....	<b>6-2</b>
Data Mode .....	6-2
Tributary .....	6-2
Analog Network .....	6-3
Digital Line/Net .....	6-3
Codec Line/Net .....	6-4
Remote Loopback .....	6-4
CSU Loopback .....	6-4
CSU Loopback w/BERT .....	6-4
Line BERT .....	6-5
<b>3. DS3 Loopbacks</b> .....	<b>6-6</b>
Line Loopback .....	6-7
Digital Loopback .....	6-7

---

Metallic Loopback .....	6-8
Remote Loopback .....	6-8
Remote All T1/E1 .....	6-8
<b>4. DS2 Loopbacks .....</b>	<b>6-9</b>
DS2 Network .....	6-9
<b>Section 7</b>	
<b>Circuit and Network Redundancy .....</b>	<b>7-1</b>
<b>1. Introduction .....</b>	<b>7-1</b>
<b>2. Nonredundant Mode .....</b>	<b>7-1</b>
<b>3. Circuit Failure Recovery Mode .....</b>	<b>7-2</b>
<b>4. Circuit and Network Failure Recovery Mode .....</b>	<b>7-3</b>
<b>Section 8</b>	
<b>Power Loss Recovery .....</b>	<b>8-1</b>
<b>1. Introduction .....</b>	<b>8-1</b>
<b>2. Nonredundant Power Mode .....</b>	<b>8-1</b>
<b>3. Power Supply Recovery Mode .....</b>	<b>8-2</b>
<b>4. Power Supply and Source Recovery Mode .....</b>	<b>8-2</b>
<b>5. Battery Backup Mode .....</b>	<b>8-3</b>
<b>Section 9</b>	
<b>Transaction Language 1 (TL1) .....</b>	<b>9-1</b>
<b>1. Introduction .....</b>	<b>9-1</b>
<b>2. Overview .....</b>	<b>9-1</b>
<b>3. TL1 Messages .....</b>	<b>9-3</b>
TL1 Responses .....	9-3
Acknowledgment Messages .....	9-3
In Progress .....	9-3
All Right .....	9-3
Output Response Messages .....	9-4
Autonomous Messages .....	9-4
<b>4. TL1 Commands .....</b>	<b>9-5</b>
TL1 Autonomous Messages .....	9-11
<b>5. TL1 Error Codes .....</b>	<b>9-17</b>
TL1 Editing .....	9-17
TL1 Editing Examples: .....	9-18
Data Dictionaries .....	9-20
TL1 Loopback Commands .....	9-30

**Appendix A**

<b>Acceptance Test Procedure</b> .....	<b>A-1</b>
<b>1. Introduction</b> .....	<b>A-1</b>
<b>2. Verifying the Installed Options</b> .....	<b>A-1</b>
<b>3. Configuring the System</b> .....	<b>A-2</b>
Accessing the Craft Port .....	A-2
Provisioning the DS3 Port .....	A-2
DS3 Configuration .....	A-3
Protection Configuration .....	A-3
Miscellaneous .....	A-3
DS2 Configuration .....	A-3
Provisioning the DS1 Ports .....	A-4
Alarm Relay Configuration .....	A-5
<b>4. Verifying the Data Integrity</b> .....	<b>A-5</b>
DS1 Daisy-Chain to DS3 (Hard) Loopback .....	A-5
DS1 to DS3 Head-to-Head Test .....	A-6
DS1 to DS3 (Hard) Loopback .....	A-7
<b>5. Verifying Alarm Notification</b> .....	<b>A-7</b>
Critical Alarm Relay Test .....	A-7
Noncritical Alarm Relay Test .....	A-8
<b>6. Verifying System Redundancy</b> .....	<b>A-8</b>
Power Supply Redundancy .....	A-8
Single Power Supply Module / Dual Power Feeds .....	A-9
Dual Power Supply Modules / Dual Power Feeds .....	A-9
Controller Card Redundancy .....	A-10
<b>7. Restoring Default Settings</b> .....	<b>A-10</b>
<b>8. Configuring the System for Traffic Readiness</b> .....	<b>A-11</b>
<b>9. Signing-off the MX2800 ATP Checklist</b> .....	<b>A-12</b>

**Appendix B**

<b>Pinouts</b> .....	<b>B-1</b>
----------------------	------------

**Appendix C**

<b>Specifications Summary</b> .....	<b>C-1</b>
<b>1. Introduction</b> .....	<b>C-1</b>
<b>2. Specifications and Features</b> .....	<b>C-1</b>
DSX-3 Network Interface .....	C-1
DSX-1 Interface(s) .....	C-1
Clocking .....	C-2
Loopbacks .....	C-2
DS3 Network .....	C-2
DS2 Interfaces .....	C-2
DSX-1 Interfaces .....	C-2
Management .....	C-2

VT100 Terminal Interface .....	C-2
Integrated Modem Interface (4200290L1, 4200290L2, 4200290L3, 4200290L4) .....	C-2
SNMP/Telnet .....	C-2
Alarms .....	C-3
Agency Approvals .....	C-3
Environment .....	C-3
Power .....	C-3
Physical .....	C-3
<b>Appendix D</b>	
<b>Acronyms/Abbreviations .....</b>	<b>D-1</b>
<b>Appendix E</b>	
<b>Glossary .....</b>	<b>E-1</b>
<b>Appendix F</b>	
<b>Warranty .....</b>	<b>F-1</b>
<b>1. Warranty and Customer Service .....</b>	<b>F-1</b>
<b>2. ADTRAN Sales .....</b>	<b>F-1</b>
<b>3. ADTRAN Technical Support .....</b>	<b>F-1</b>
<b>4. ADTRAN Repair/CAPS .....</b>	<b>F-1</b>
<b>5. Repair and Return Address .....</b>	<b>F-1</b>
<b>Index .....</b>	<b>I-1</b>

## Figures

Figure 1-1. E1 Patch Panel .....	1-4
Figure 1-2. Installing Fan Faceplate .....	1-4
Figure 2-1. DC Power Connector .....	2-3
Figure 2-2. The Breakout Panel .....	2-5
Figure 2-3. MX2800 Rear View .....	2-6
Figure 2-4. MX2800 Front Panel .....	2-8
Figure 2-5. Main Menu .....	2-10
Figure 2-6. Status Menu .....	2-11
Figure 2-7. Statistics Menu .....	2-12
Figure 2-8. Configuration Menu .....	2-12
Figure 2-9. Loopback Menu .....	2-13
Figure 2-10. Telnet Client Menu .....	2-14
Figure 2-11. Replacing or Installing Cards .....	2-18
Figure 3-1. Configuration Menu .....	3-1
Figure 3-2. Configuration Menu Tree .....	3-3
Figure 3-3. Network Configuration Menu .....	3-4
Figure 3-4. T1/E1 Interface Menu .....	3-8
Figure 3-5. T1/E1 State Menu .....	3-9
Figure 3-6. Set Multiple Menu .....	3-10
Figure 3-7. T1/E1 Line Coding Menu .....	3-11
Figure 3-8. T1/E1 Line Length Menu .....	3-12
Figure 3-9. Loopback Detection Menu .....	3-13
Figure 3-10. Circuit Protection Menu .....	3-14
Figure 3-11. Line Identification Menu .....	3-15
Figure 3-12. System Management Configuration Menu .....	3-16
Figure 3-13. Dialup Options Menu .....	3-19
Figure 3-14. Trap Generation Menu .....	3-22
Figure 3-15. Alarm Relay Configuration Menu .....	3-34
Figure 3-16. Equipment Identification Menu .....	3-36
Figure 3-17. System Utilities Menu .....	3-38
Figure 3-18. Indication of a Saved Configuration and Alarm Log .....	3-44
Figure 4-1. Status Menu .....	4-1
Figure 5-1. Statistics Menu .....	5-1
Figure 5-2. DS3 Statistics Menu .....	5-2
Figure 5-3. DS3 Current 15 Minute Alarm Count Screen .....	5-3
Figure 5-4. DS3 24-Hour Alarm History Screen .....	5-4
Figure 5-5. DS3 Performance Parameters (Current 15 Minutes) .....	5-5
Figure 5-6. DS3 Performance Parameters (24 Hour History) .....	5-6
Figure 5-7. DS3 Performance Parameters (Totals) .....	5-7
Figure 5-8. DS2 Current 15 Minute Alarm Count Screen .....	5-9
Figure 5-9. DS2 RAI 24-Hour Alarm History .....	5-10
Figure 5-10. DS2 Performance Parameters (Current 15 Minutes) .....	5-11
Figure 5-11. DS2 PBERR 24-Hour Alarm History .....	5-12
Figure 5-12. T1/E1 Port Local Statistics Menu .....	5-13
Figure 5-13. Protection Switch Statistics Menu .....	5-14
Figure 5-14. Alarm Log .....	5-15
Figure 6-1. Loopback Menu .....	6-1
Figure 6-2. Loopback Control Menu .....	6-2
Figure 6-3. Tributary Loopback Test .....	6-3

---

Figure 6-4. Analog Network Loopback . . . . .	6-3
Figure 6-5. Digital Line/Network Loopback. . . . .	6-3
Figure 6-6. Codec Loopback . . . . .	6-4
Figure 6-7. Loopback Menu with BERT Selected. . . . .	6-5
Figure 6-8. DS3 Loopback Menu . . . . .	6-6
Figure 6-9. Line Loopback Test . . . . .	6-7
Figure 6-10. Digital Loopback. . . . .	6-7
Figure 6-11. Metallic Loopback Test . . . . .	6-8
Figure 6-12. DS2 Loopback Menu . . . . .	6-9
Figure 6-13. DS2 Network Loopback Test . . . . .	6-9
Figure 7-1. Nonredundant Mode . . . . .	7-1
Figure 7-2. Circuit Failure Recovery Mode. . . . .	7-2
Figure 7-3. Circuit and Network Failure Recovery Mode . . . . .	7-3
Figure 8-1. Nonredundant Power Mode . . . . .	8-1
Figure 8-2. Power Supply Failure Recovery Mode. . . . .	8-2
Figure 8-3. Power Supply and Source Failure Recovery Mode . . . . .	8-3
Figure 8-4. Battery Backup System . . . . .	8-4



## Tables

Table 2-1.	DC Connector Symbol Definitions	2-3
Table 2-2.	MX2800 Review View Identifiers	2-6
Table 2-3.	LED Conditions for Active Cards	2-16
Table 2-4.	LED Conditions for Standby Cards	2-17
Table 2-5.	T1/E1 LED Conditions	2-17
Table 3-1.	XCV Threshold Limits	3-6
Table 3-2.	XCV Threshold Limits for T1/E1	3-15
Table 3-3.	Trap Descriptions	3-22
Table 3-4.	Console Menu User Privileges	3-30
Table 3-5.	Types of Alarms in Alarm Relay Configuration	3-34
Table 3-6.	Syslog Severity Levels	3-37
Table 3-7.	Self-Test Results	3-39
Table 4-1.	Network State Conditions	4-2
Table 4-2.	Alarm Conditions	4-2
Table 4-3.	Remote Alarm Conditions	4-3
Table 4-4.	Power Supply Conditions	4-4
Table 4-5.	System State Alarm Types	4-4
Table 4-6.	Controller Card States	4-5
Table 4-7.	Protection Types	4-5
Table 4-8.	DS2 States	4-6
Table 4-9.	T1/E1 States	4-6
Table 5-1.	Alarm Counts	5-2
Table 7-1.	Configuration Requirements for Circuit Recovery	7-2
Table 9-1.	TL1 Account Privileges	9-2
Table 9-2.	TL1 Commands	9-6
Table 9-3.	MX2800 Alarm Events	9-12
Table 9-4.	MX2800 Informational Events	9-16
Table 9-5.	TL1 Error Codes	9-17
Table 9-6.	TL1 Editing Data Dictionary for DS3	9-20
Table 9-7.	TL1 Editing Data Dictionary for DS2	9-23
Table 9-8.	TL1 Editing Data Dictionary for DS1	9-24
Table 9-9.	TL1 Editing Data Dictionary for EQPT	9-27
Table 9-10.	DS3 TL1 Loopback Commands	9-30
Table 9-11.	DS2 TL1 Loopback Commands	9-30
Table 9-12.	DS1 TL1 Loopback Commands	9-31
Table A-1.	MX2800 ATP Checklist	A-12
Table B-1.	Craft Port Pin Assignments	B-1
Table B-2.	LAN Port Pin Assignments	B-1
Table B-3.	Modem Port Pin Assignment	B-2
Table B-4.	Amphenol Pin Assignments	B-2

This page is intentionally blank.

# Section 1

## Product Overview

### 1. INTRODUCTION

The MX2800 is an M13 multiplexer that consolidates T1 and E1 signals into a T3 circuit. This unit provides a cost-effective, versatile tool for combining independent T1s, E1s, or a combination of the two over the same T3 circuit.

The MX2800 houses two hot-swappable controller cards which provide 1:1 redundancy for the T1 and T3 signals, as well as the T3 connections.

Embedded simple network management protocol (SNMP) and Telnet are available through the modem port using serial line internet protocol/point-to-point protocol (SLIP/PPP) or through the 10Base-T Ethernet port. Using the Management Information Base II (MIB II), RFC 1407 standards, and an ADTRAN enterprise MIB, the MX2800 can be configured, monitored, and diagnosed with standard SNMP network management programs such as Hewlett Packard's HP OpenView™ and Cabletron's Spectrum®. In addition, the SysLog Host Daemon allows remote monitoring, collecting, and logging of MX2800 events in realtime. This information is useful during installation setups and/or troubleshooting.

Complete configuration, loopbacks, and performance monitoring are available through SNMP, Telnet, or a VT100 terminal interface. This connection can be made via Ethernet, a local EIA-232 link, or through the built-in V.34 modem. The modem can dial out a "cry for help" for units located in unmanned facilities. The MX2800 is designed for installation in a 19-inch or 23-inch rack.

The major features of the MX2800 are as follows:

- Built-in 1:1 redundancy
- Hot-swappable controller cards
- Independent, dual-load sharing, redundant power supplies
- Embedded SNMP and Telnet management through 10Base-T Ethernet or SLIP/PPP dialup
- Detailed performance monitoring for local and remote units
- Simplified configuration through the VT100 terminal menu structure
- Integrated V.34 modem for dial-up and dial-down access
- Capability of backhauling multiple service types (T1/E1)
- AC or DC power
- Available -48V or 24V power supplies
- External DS3 clock option
- M13 and C-bit signaling support

- NEBS Level 3 compliant

---

**NOTE**

Information regarding the built-in modem applies to the part numbers 4202290L1, 4202290L2, 4202290L3, and 4202290L4.

---

## 2. CONTROLLER CARD 1:1 REDUNDANCY

The MX2800 supports two hot-swappable controller cards which provide 1:1 redundancy for the T1 and T3 signals and connections. With two cards installed, the MX2800 can recover from circuit or network failure. Refer to [Section 7, Circuit and Network Redundancy](#) for more information.

## 3. T3 OVERVIEW

A T3 provides the same bandwidth as 28 T1s. Typically, leasing a T3 line costs the same as eight to ten T1s. Using the MX2800, a single T3 can provide internet connectivity and voice (local and long distance) to individual sites across up to 28 individual DSX-1s. T3 is also extremely cost effective for backhauling local and long distance voice.

## 4. SNMP

The MX2800's embedded SNMP feature allows the unit to be accessed and controlled by a network manager through the 10Base-T local area network (LAN) port. The MX2800 supports the MIB-II standard, RFC 1213, and the ADTRAN Enterprise Specific MIB.

---

**NOTE**

MIB files are available from ADTRAN in the support section of the ADTRAN Web page at [www.adtran.com](http://www.adtran.com).

---

The term SNMP broadly refers to the message protocols used to exchange information between the network management system (NMS) and the managed devices, as well as to the structure of device management databases. SNMP has three basic components: the network manager, the agent, and the MIB.

### Network Manager

The network manager is a set of control programs that collect, control, and present data pertinent to the operation of the network devices. These programs reside on a network management station.

## Agent

The agent is a control program that resides in every network device. This program responds to queries and commands from the network manager, returns requested information or invokes configuration changes initiated by the manager, and sends unsolicited traps to the manager.

## MIB

An MIB is an industry standard presentation of all status and configuration parameters supported by a network device.

## 5. TELNET

Telnet provides a password protected, remote login facility to the MX2800 that allows a remote user to control the MX2800 through the terminal menus. Only one Telnet menu session may be active at a time.

## 6. TL1

Transaction Language 1 (TL1) is an ASCII-based language that supports both command-response and autonomous (NE) message generation. Commonly, TL1 is used over an X.25 packet network but is completely independent of any physical layer protocols. For the MX2800, TL1 is implemented as a Telnet session running over Ethernet or PPP. Currently, up to eight TL1 Telnet connections can be active at a time.

## 7. AVAILABLE OPTIONS

The following optional equipment is available for use with the MX2800. Contact a local distributor or the ADTRAN Sales Department for more information. Refer to [Appendix F](#), [Warranty](#) for contact information.

### Breakout Panel (P/N 1200291L1)

The optional breakout panel connects to the MX2800 and provides 28 RJ connectors for the individual T1s/E1s. Shipment includes two six-foot, 64-pin to 64-pin amphenol cables which allow direct cabling to the MX2800. Refer to [Connecting the Breakout Panel](#) on page 2-5 for more information.

### E1 Patch Panel (P/N 1200291L5)

The optional E1 patch panel connects to the MX2800 and provides 28 pairs of BNC connectors for E1 deployment (21 of which are used for E1 deployment). See [Figure 1-1](#) on page 1-4.

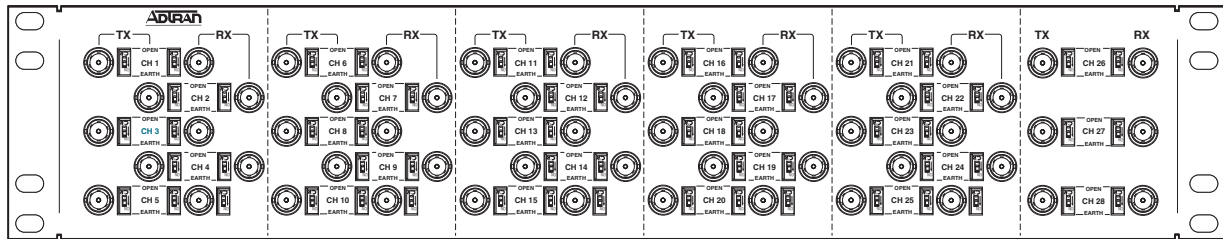

Figure 1-1. E1 Patch Panel

Shipment includes two six-foot, 64-pin to 64-pin amphenol cables for direct cabling to the MX2800. Refer to [Connecting the E1 Patch Panel](#) on page 2-5 or more information.

## Battery Backup (P/N 4175043L2)

The battery backup system provides power backup in the event of power loss. This system includes the battery, an AC battery charger, and an alarm cable.

## Fan Faceplate (P/N 1200466L1)

The MX2800 fan faceplate provides the means for additional heat dissipation, allowing multiple units to be stacked directly over each other. The fan faceplate replaces the original faceplate. It is used with the 1202289L1, 1202289L2, and 1202289L3 power supplies. [Figure 1-2](#) shows how the fan faceplate is installed on the chassis.

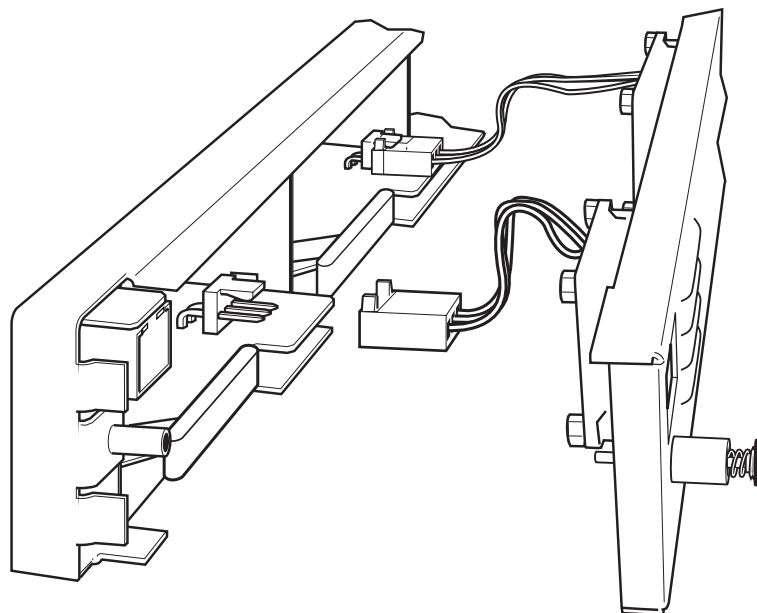

Figure 1-2. Installing Fan Faceplate

## **Section 2**

# **Installation and Operation**

### **1. INTRODUCTION**

The first three tasks for installing and operating the MX2800 are to unpack, inspect, and power up. The next three subsections detail the tasks. Additional subsections provide information for mounting the MX2800 into an equipment rack, making the proper connection to the back panel, identifying the front panel indicators and modular jack, and outlining the addition or removal of a card.

### **2. RECEIVING INSPECTION**

Carefully inspect the MX2800 for any damage that might have occurred in shipment. If damage is suspected, file a claim immediately with the carrier, keep the original packaging for damage verification and/or returning the unit, and contact ADTRAN Customer Service. For warranty information, refer to [Appendix F, Warranty](#).

### **3. ADTRAN SHIPPING CONTENTS**

After unpacking the MX2800 unit but before an initial power up, be sure that the following items are present:

- MX2800 unit
- DC or AC power supply (Two power supplies come with the Redundant versions.)
- Controller card (Two cards come with the Redundant versions.)
- 8-pin to 6-pin modular cable (modem version only)
- 8-pin to 8-pin modular cable
- 8-pin modular to DB-9 female connector
- Two 4-position terminal lug connectors
- 3-position terminal lug connector
- Six-foot AC power cable (AC version only)
- Mounting ears and screws for 19-inch or 23-inch rack installation
- User manual or CD containing the User Manual

---

**NOTE**

MIB files are available from ADTRAN in the support section of the ADTRAN Web page at [www.adtran.com](http://www.adtran.com).

---

## 4. POWER UP

The AC version of the MX2800 is provided with a 6-foot power cable terminated in a three-prong plug which is connected to a grounded 120 VAC power receptacle.

---

**NOTE**

Power to the AC version of the MX2800 must be provided from a grounded 120 VAC power receptacle.

---

The DC version of the MX2800 is provided with two 4-position modular terminal lug connectors. These connectors simplify the initial wiring and connection or disconnection of the DC power when replacing rackmount units.

---

**NOTE**

A 3-amp fuse is recommended for use in the fuse and alarm panel that feeds the MX2800.

---

For more detailed information on power connections, refer to *Section 8, Power Loss Recovery*.

Once the modular connector is wired, push it firmly into one of the rear panel power connectors. **Figure 2-1** on page 2-3 and **Table 2-1** on page 2-3 illustrate the DC power connector and give definitions for the four connector symbols.

---

**NOTE**

The chassis should be connected to an earth ground using the ground stud located between the AC and DC power sources on the rear panel.

---



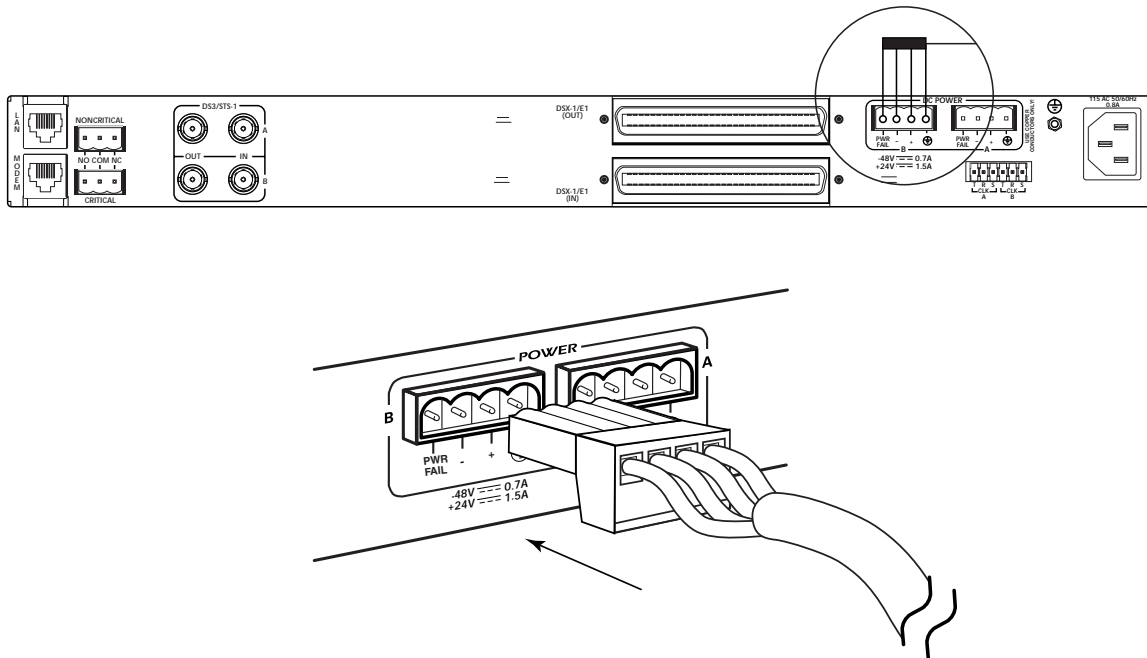

Figure 2-1. DC Power Connector

Table 2-1. DC Connector Symbol Definitions

Symbol	Definition
<b>PWR FAIL</b>	Battery backup connector. If the AC fails, a trap is sent to alert user when connected to the 4175043L2 battery backup or equivalent system.
<b>-</b>	Negative side of DC power source (usually -48 VDC)
<b>RET</b>	Positive side of DC power source (usually ground)
$\oplus$	Frame Ground

The following UL requirements must be met during installation of the MX2800 DC version:

1. Disconnect all power sources prior to servicing. Unit may use multiple power sources.
2. Input: Minimum 48 VDC, 0.8 amps
3. Input: Minimum 120 VAC, 0.32 amps
4. Connect to a reliably grounded -48 VDC source which is electrically isolated from the AC source. Use 24 VDC source for 1202289L3.
5. The branch circuit overcurrent protection must be a fuse or circuit breaker rated minimum 48 VDC, maximum 20 amps.

6. A readily accessible disconnect device that is suitably approved and rated must be incorporated in the field wiring.
7. The chassis should be connected to an earth ground using the ground stud located between the AC and DC power sources on the rear panel.
8. The unit must be installed in accordance with the requirements of NEC NFPA 70.
9. The unit must be installed in accordance with Articles 400 and 364.8 of the National Electrical Code NFPA 70 when installed outside of a Restricted Access Location (i.e., Central Office, behind a locked door, service personnel area only).
10. Care should be taken not to upset the stability of the equipment rack after installation is complete.

---

**CAUTION**

Use copper conductors only for DC power and ground connection.

---

## 5. RACKMOUNT INSTALLATION

The MX2800 can be mounted into a standard 19-inch or 23-inch equipment rack. Follow these steps to mount the unit into a rack:

1. Install the mounting flanges on each side of the MX2800 at one of the three available positions.

---

**CAUTION**

Be sure to install the flanges with the screws provided.

---

2. After the flanges have been installed, position the MX2800 at the correct location within the rack and secure the mounting flanges to the mounting rails of the rack.
3. Make all network, DTE, and power connections to the rear of the unit. Refer to *Power Up* on page 2-2 for more information on making the DC power connection.
4. Using the 8-position modular to DB-9 female connector and the 8-pin to 8-pin modular cable, connect a VT100 terminal device to the **CRAFT** port on the front panel of the unit.

---

**NOTE**

Two MX2800s can be stacked with out any spacing between the units. ADTRAN recommends 1U (1.75") of separation above and below the two stacked units. This spacing allows the units to dissipate heat. The design of the MX2800 uses the chassis to distribute heat generated by the unit's internal cards. This design allows the units to operate without a cooling fan, thus increasing overall reliability of the units.

---

## Connecting the Breakout Panel

The optional breakout panel (P/N 1200291L1) connects to the MX2800 via the **IN** and **OUT** amphenol connectors located on the back of the unit and provides 28 RJ connectors for the individual T1s/E1s. Shipment includes two six-foot, 64-pin to 64-pin amphenol cables for direct cabling to the MX2800. Connect the breakout panel's **IN** amphenol connector to the MX2800's **IN** amphenol connector and the breakout panel's **OUT** amphenol connector to the MX2800's **OUT** amphenol connector. See [Figure 2-2](#).

### FRONT VIEW

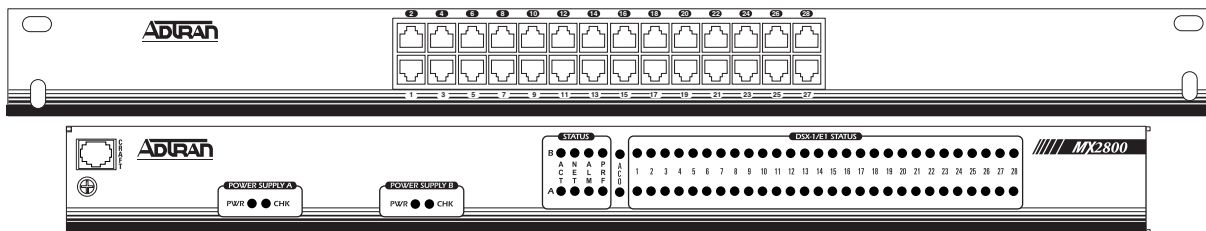

### REAR VIEW

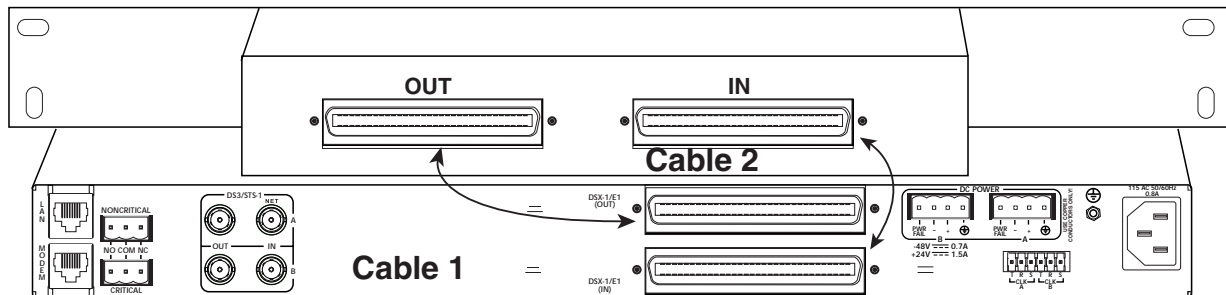

Figure 2-2. The Breakout Panel

## Connecting the E1 Patch Panel

The optional E1 patch panel (P/N 1200291L5) connects to the MX2800 via the **TX** and **RX** amphenol connectors located on the back of the unit and provides 28 pairs of BNC connectors for the individual T1/E1s. Shipment includes two 6-foot, 64-pin to 64-pin amphenol cables for direct cabling to the MX2800. Connect the E1 patch panel's **TX** amphenol connector to the MX2800's **IN** amphenol connector and the E1 patch panel's **RX** amphenol connector to the MX2800's **OUT** amphenol connector.

## 6. REAR PANEL

The MX2800 rear panel is equipped as follows:

- Ethernet local area network (LAN) port
- Modem port
- Two alarm output terminal blocks
- Two sets of DS-3 in/out jacks
- Two amphenol connectors
- DC/AC power connection
- Ground stud
- Three-prong AC connection
- Wire-wrap pins for external connection of BITS clock (STS-1)

Descriptions for the items shown in [Figure 2-3](#) are explained in [Table 2-2](#). Pin assignments are given in the tables in [Appendix B, Pinouts](#).

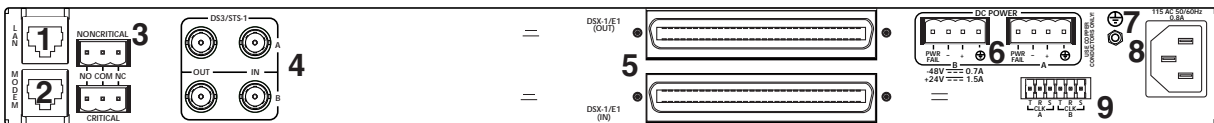

**Figure 2-3. MX2800 Rear View**

**Table 2-2. MX2800 Review View Identifiers**

#	Item	Function
1	Ethernet LAN	10Base-T Ethernet connection
2	Modem	Telephone line connection for internal V.34
3	Noncritical/Critical	Connections for external audible/visual alarms
4	DS3/STS-1	T3 service connection for controller cards A and B
5	DSX-1/E1	64-pin female amphenol connectors for T1/E1s
6	Power	DC power connection
7	⊕	Ground stud
8	115 VAC 50/60 Hz	AC power connection
9	BITS Clock	Wire-wrap pins for external connection of BITS clocks

---

## LAN Port

The LAN port is an 8-pin modular connector that provides a 10Base-T Ethernet LAN interface. This LAN interface is used for SNMP and Telnet control.

---

### NOTE

Connect the LAN port to intra-building wiring only.

---

## Modem Port

The modem port is an 8-pin modular jack that provides a telephone line (POTS) connection for the internal V.34 modem.

---

### NOTE

Information regarding the built-in modem applies to the part numbers 4202290L1, 4202290L2, 4202290L3, and 4202290L4.

---

The MX2800 can be configured as a dial-in host and also as a dial-out-on-trap device (the unit dials out to a specified host to report error conditions).

## Noncritical and Critical Alarm Connectors

The alarm connectors connect to the three contacts of a Form C type relay on the main board of the MX2800. This relay is activated any time the MX2800 detects an alarm condition on the T3 network interface. Both **NC** (normally closed) and **NO** (normally open) contacts are provided.

Connect alarms to one of the three-position modular terminal lug connectors. These connectors simplify the initial wiring and connection or disconnection of the alarms when replacing rackmount units. Once a modular connector is wired, push it firmly into the rear panel **NONCRITICAL** or **CRITICAL** connector.

The alarm functions can be enabled or disabled through the Alarm Relays section of the Configuration menu. For more information, refer to [Alarm Relay Configuration](#) on page 3-33.

## DSX-3 Interfaces

The DSX-3 network interfaces are full-duplex circuits provided by four BNC coaxial cable connections (two for each controller card). The receive data from the network is connected to the Rx (**IN**) connectors, while the transmit data from the MX2800 is connected to the Tx (**OUT**) connectors. Refer to [Section 7, Circuit and Network Redundancy](#) for more specific information about connecting the DS3 interface in redundant and nonredundant systems.

**NOTE**

DSX-3 interfaces must be connected using coaxial cables that have the shields grounded at both ends.

**DSX-1/E1 Interfaces**

The DSX-1/E1 interfaces are 64-pin amphenol connectors. These interfaces provide Tx and Rx connections between the unit and equipment such as wire-wrap patch panels, punch-down panels, or breakout panels.

**NOTE**

Connect the DSX-1/E1 interfaces to intra-building wiring only.

**Power Connection**

The DC power connections are described in *Power Up* on page 2-2.

**7. FRONT PANEL**

The MX2800 front panel is shown in **Figure 2-4**. Descriptions of each part of the front panel follow:

- *Craft Port* on page 2-8
- *ACO Buttons* on page 2-15
- *Power Supply A/B Status LEDs* on page 2-15
- *Controller Cards Status LEDs* on page 2-15
- *TI/E1 Status LEDs* on page 2-17

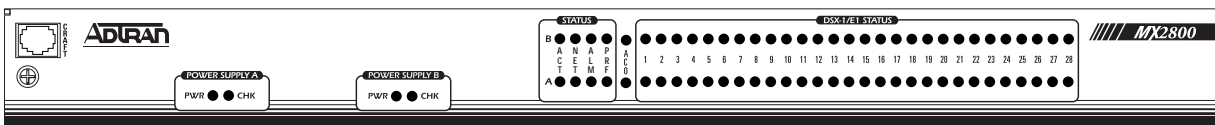

**Figure 2-4. MX2800 Front Panel**

**Craft Port**

The craft port, an 8-pin modular jack, provides connection to a VT100 EIA-232 compatible interface (using the supplied 8-pin modular to DB-9 female connector and the 8-pin to 8-pin modular cable).

## Establishing Terminal Connection

---

### NOTE

A Telnet menu session has priority over a terminal menu session through the craft port. If a terminal menu session is active when a Telnet menu session is initiated, the terminal menu session will be disabled while the Telnet menu session is active.

---

To connect the MX2800 to a VT100 terminal, follow this procedure:

1. Configure the VT100 terminal for 9600, 19200, 38400, or 57600 baud, 8-bit characters, no parity, and one stop bit (xxxx, 8N1).
2. Using the ADTRAN-provided terminal interface cable adapter, connect the DTE port of a terminal to the 8-pin modular jack labeled **CRAFT** on the MX2800 front panel.
3. Initialize the terminal session.
4. Press ENTER repeatedly until the username prompt appears.
5. Enter the username. The factory default username is **adtran**. The password prompt appears.
6. Enter the password. The factory default password is **adtran**. The Main Menu appears. See [Figure 2-5](#) on page 2-10.

## Main Menu

Make selections on the Main Menu by entering the number corresponding to the chosen parameter or the desired key strokes. Refer to [Navigating Within the Menus](#) on page 2-10

---

### NOTE

A new Telnet session may take priority over an existing one if a username and password are provided that have ADMIN privileges

---

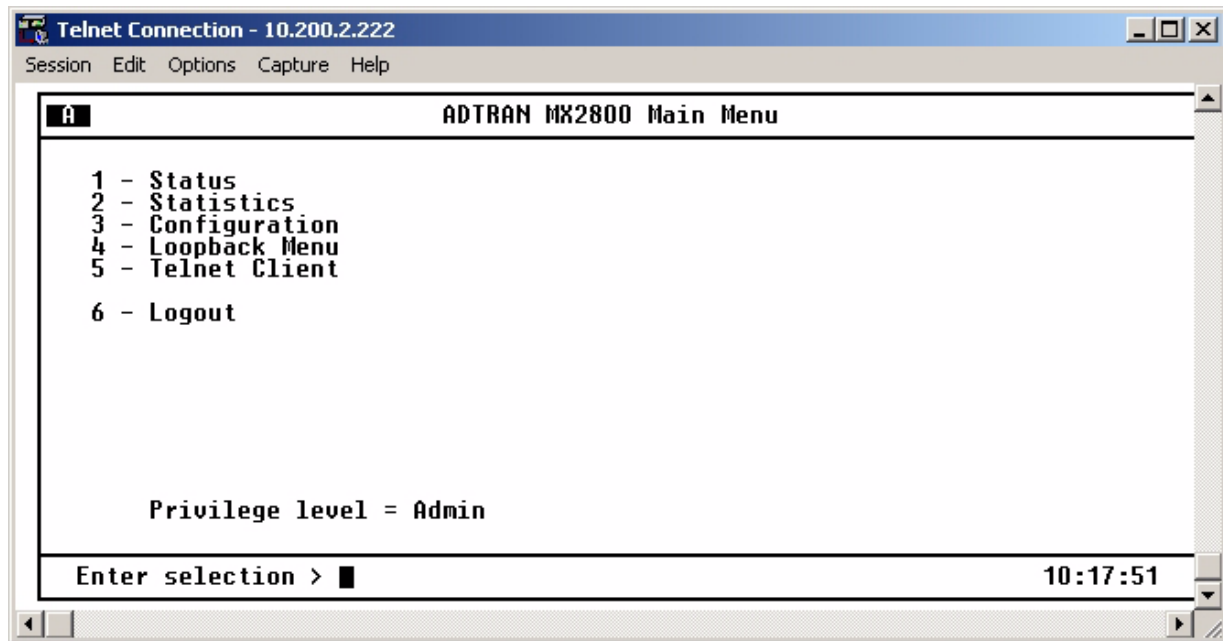

Figure 2-5. Main Menu

**NOTE**

The letter displayed in the upper left-hand corner of the terminal menu indicates which controller card is active (A or B).

**Navigating Within the Menus**

Navigate within the MX2800 terminal menus using the following procedures:

To...	Press...
select an item	the number corresponding to your choice, and then press the ENTER key
scroll left and right within the same screen	the left and right arrow keys. Additional screens are available when < or > is displayed in the top portion of the menu
return to the previous menu	the ESC key
end the terminal session	CTRL+C
refresh the display	CTRL+R



To...	Press...
scroll up and down within the same screen	the up and down arrow keys. Additional screens are available when ^ or v is displayed in the top portion of the menu.

The MX2800 Main Menu consists of the following sections:

## Status

Provides information on the current state of the DS3, power supplies, system, DS2s, and T1/E1 lines. See [Figure 2-6](#) for an illustration. Refer to [Section 4, Status](#) for more detailed information.

```

Telnet Connection - 10.200.2.222
Session Edit Options Capture Help

A
Status

DS3 State Card A Card B DS2 State
State = Normal N/A (1-7) = OK OK OK OK OK OK
Alarm = None N/A
Port = DS3 A None
Rx Framing = C-BIT
Remote = Normal

Power Supply State
Card A = Not installed
Card B (DC) = Normal

System State
Alarm = None
Card = (A) Active, (B) Not installed
Protection = None
Card Comm. = Non-redundant

T1/E1 State
(1-4) = OK OK OK OK
(5-8) = OK OK OK OK
(9-12) = OK OK OK OK
(13-16) = OK OK OK OK
(17-20) = OK OK OK OK
(21-24) = OK OK OK OK
(25-28) = OK OK OK OK

1 - Acknowledge Alarms (ACO)

Enter selection > 10:20:18

```

Figure 2-6. Status Menu

## Statistics

Provides detailed statistical information (both current and historical) for the DS3, DS2s, and T1/E1 lines. See [Figure 2-7](#) on page 2-12 for the Statistics menu. Refer to [Statistics](#) on page 5-1 for more detailed information.

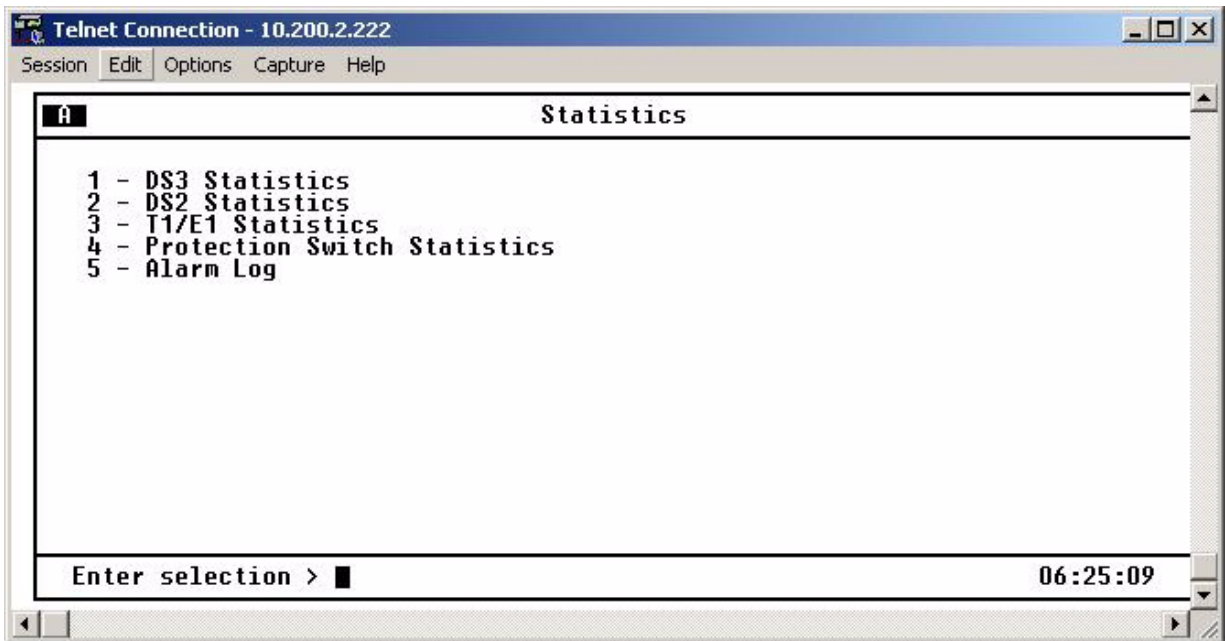

Figure 2-7. Statistics Menu

## Configuration

Sets DS3 network, T1/E1, and system management parameters. See [Figure 2-8](#). Refer to [Section 3, Configuration](#) for more detailed information.

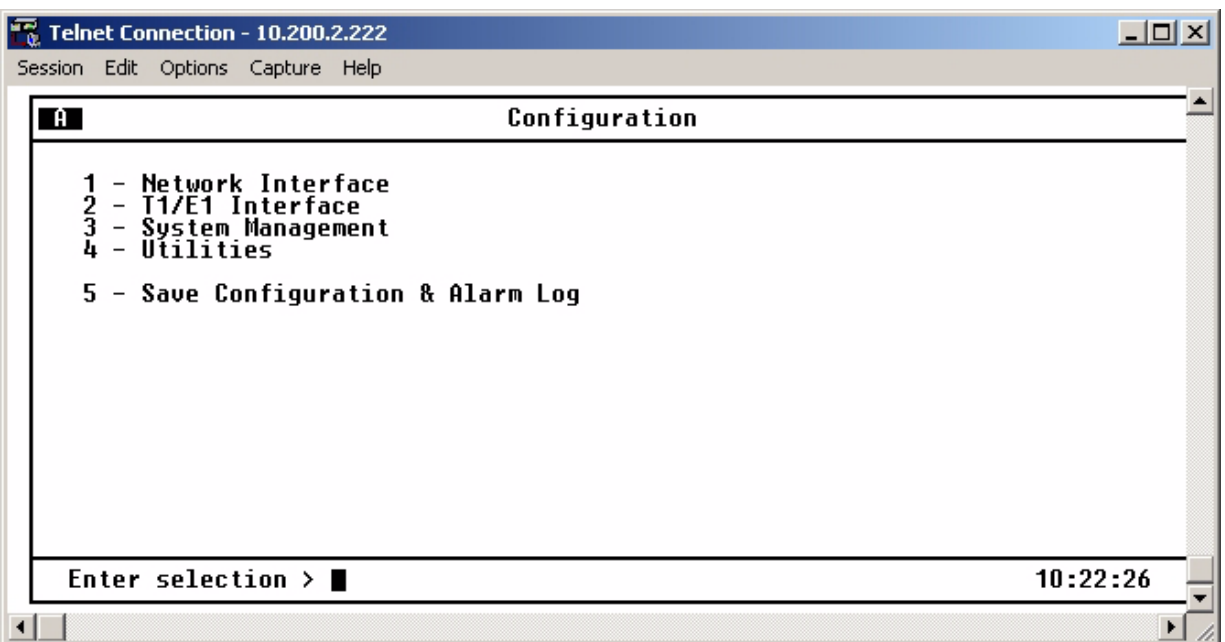

Figure 2-8. Configuration Menu

## Loopbacks

Performs loopback tests over the DS3, DS2s, or T1/E1 lines. See [Figure 2-9](#) for an illustration of the Loopback Menu. Refer to [Section 6, Loopbacks](#) for more detailed information.

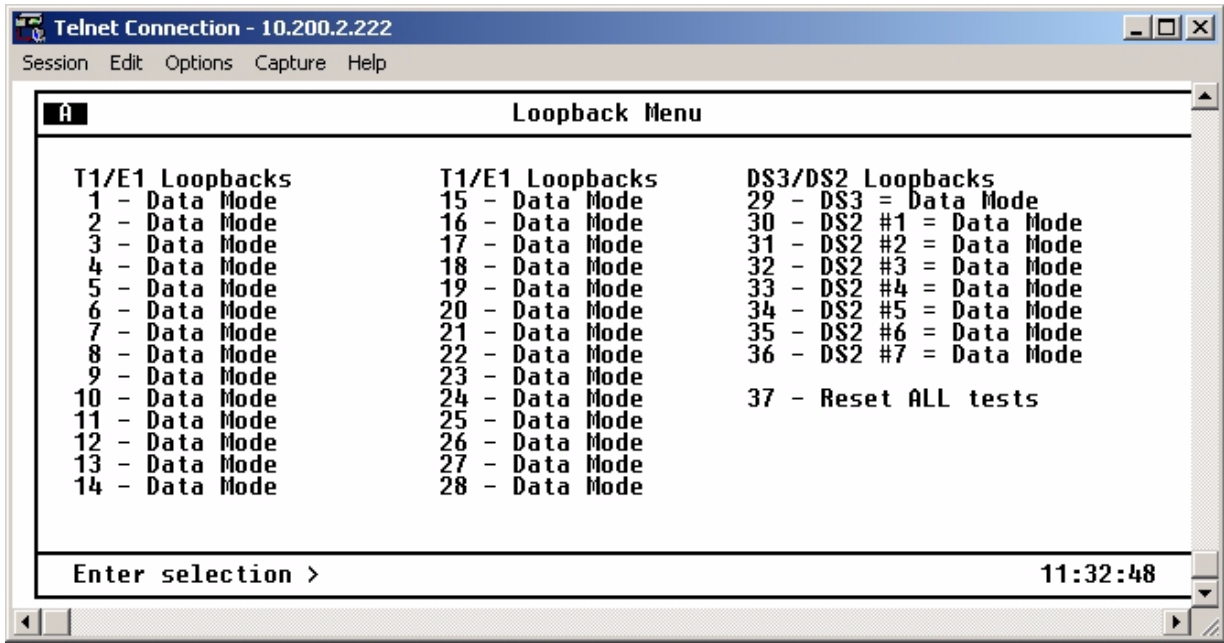
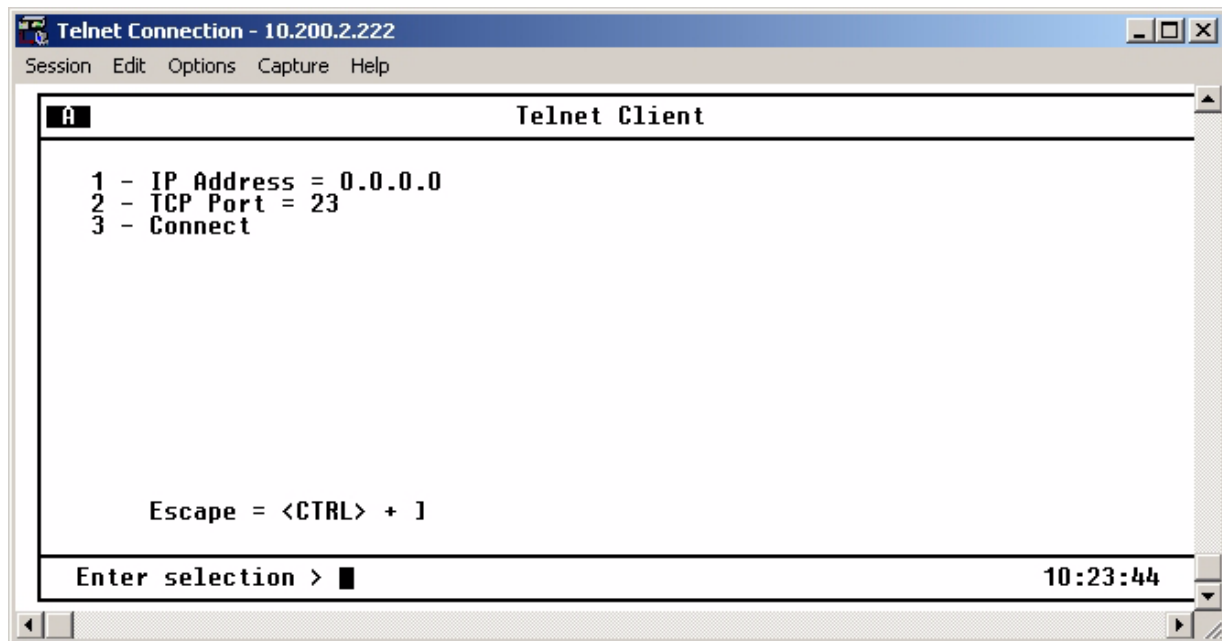

Figure 2-9. Loopback Menu

## Telnet Client

A Telnet session may be established with any device visible in the network from the MX2800. See [Figure 2-10](#) on page 2-14 for an illustration of the Telnet Client menu.



**Figure 2-10. Telnet Client Menu**

From the Telnet Client menu, specify the destination IP address and the desired TCP port number. Attempt to establish the TCP connection.

Once the connection is established, the new session becomes visible in the menu and all user inputs are forwarded to the destination address. When the session with the destination device is terminated, the MX2800 menu returns to the Telnet Client menu and all user input are processed locally by the MX2800.

---

**NOTE**

An attempted or established connection can be terminated by using the escape sequence. This escape sequence is displayed for reference at the bottom of the Telnet Client menu and consists of the control key plus the right bracket key (CTRL+]).

---

A connection can be established with the Telnet Client regardless of how the MX2800 (via craft, LAN port, modem port, or IP forwarding over the DS3 PMDL link) is accessed. The MX2800 supports only one menu session at a time.

---

**CAUTION**

The MX2800 does not reliably support binary file transfers (XModem, YModem, etc.) over the built-in Telnet Client because of compatibility issues involving the handling of certain control characters by some terminal applications and binary file transfer protocols.

---

## Logout

The Logout selection ends the terminal session and logs out of the system. A valid username and password are required before a new session can begin. The unit will also log out of a terminal session automatically if the session remains inactive for a certain period of time. For more information, see the section *Terminal Time Out* on page 3-33.

## Privilege Level

The privilege level of the currently active terminal session is displayed in this field.

## ACO Buttons

The **ACO** (alarm cut off) buttons turn off an active audible alarm. Since the buttons are recessed, use a pen or other pointed instrument to press them. Once an **ACO** button deactivates an alarm, the alarm remains disabled until the condition has cleared.

Alarms can also be turned off remotely by using a selection found in the Status menu. For more information, refer to *Acknowledge Alarms (ACO)* on page 4-6.

## LED Descriptions

The MX2800 has LED status indicators for the power supplies, the DS3 state, the controller cards, and the individual T1s/E1s. These LEDs are identified below:

### Power Supply A/B Status LEDs

The **PWR** LED is active when the unit is on and receiving full power. The **CHK** LED is active when the power supply is failing or is providing low power and needs to be checked.

### Controller Cards Status LEDs

The **STATUS** LEDs apply to the two controller cards. The LEDs provided are **ACT** (active), **DS3**, **ALM** (alarm), and **PRF** (performance). Various conditions are indicated by the state of the LED (its color and whether it blinks, alternates color, or is on solid). The condition descriptions vary depending on whether the LED represents the active controller card or the controller card on standby. The following tables provide LED definitions for the active cards (see [Table 2-3](#) on page 2-16) and T1/E1 cards (see [Table 2-4](#) on page 2-17).

Table 2-3. LED Conditions for Active Cards

LED	LED State	Card Condition
<b>ACT</b>	Green solid	Normal (all OK)
	Green/amber alternating	Normal + console open
	Red solid	Self test failed
	Amber solid	Software update in progress
	Red/amber alternating	Self test failed + console open
	Red blinking	Card failure
<b>NET</b>	Green solid	Normal (all OK)
	Red blinking	LOS
	Red solid	AIS, LOF, RAI, idle alarms
	Amber solid	In test (Local)
	Amber flashing	In test (Remote)
	Red/amber alternating	In test with alarms
<b>ALM</b>	Green solid	Normal (no alarm)
	Red blinking	Critical alarm
	Red solid	Non-critical alarm
	Amber blinking	Critical alarm suppressed ( <b>ACO</b> button was pushed)
	Amber solid	Non-critical alarm suppressed ( <b>ACO</b> button was pushed)
<b>PRF</b>	Green solid	Normal (all OK)
	Red flash (once per event)	Single/burst CV
	Red blinking	Continuous code violations
	Red solid	XCV threshold exceeded (refer to <i>XCV Threshold</i> on page 3-15)

---

**NOTE**

The **PRF** (performance) LED refers to the DS3 only

---

**Table 2-4. LED Conditions for Standby Cards**

LED	LED State	Card Condition
<b>ACT</b>	Green blinking	Normal (all OK)
	Amber solid	Software update in progress
	Red blinking	Self test failed
<b>NET</b>	Off	Normal (all OK)
	Red blinking	DS3 failure
<b>ALM</b>	Off	Normal (no alarm)
<b>PRF</b>	Off	Normal (all OK)

### T1/E1 Status LEDs

These LEDs apply to each individual T1 or E1. Various conditions are indicated by the state of the LED (its color and whether it blinks, alternates color, or is on solid). The condition descriptions vary depending on whether the LEDs represent T1s or E1s of the active controller card or the controller card on standby.

**Table 2-5** provides LED definitions for the active and standby cards.

**Table 2-5. T1/E1 LED Conditions**

LED	LED State	T1/E1 Condition
<b>Active Card</b>	Green solid	Normal (all OK)
	Off	Disabled
	Red blinking	LOS
	Red flash (once per event)	Single/burst CV
	Red solid	XCV threshold exceeded or AIS (refer to <i>XCV Threshold</i> on page 3-15)
	Amber solid	In test (Local)
	Green/amber alternating	In test (Remote)
	Red/amber alternating	In test with alarms
<b>Standby Card</b>	Off	Normal (all OK) or N/A (in the case of E1 configuration)
	Red blinking	T1/E1 failure

## 8. REPLACING OR INSTALLING CARDS

The MX2800 is designed with hot-swappable controller cards and power supplies. To replace or install a controller card or power supply, remove the front cover of the MX2800 with a phillips head screwdriver. Once the front of the MX2800 has been removed, the power supply and controller card slots will be visible. The two power supplies are located at the left of the chassis, and the controller cards are stacked on the right side of the chassis. To remove a card, use the locking lever(s) to pull the backplane connector away from the backplane. Once the backplane connector has been disconnected, carefully pull the card straight out of the chassis. To replace or install a card, line up the card with the guide grooves and carefully insert the card into the chassis until the backplane connector reaches the backplane. Finally, use the locking levers to seat the card all the way into the slot of the chassis. Once all cards have been replaced or installed, replace the front cover of the MX2800. **Figure 2-11** shows how to remove and replace the front cover.

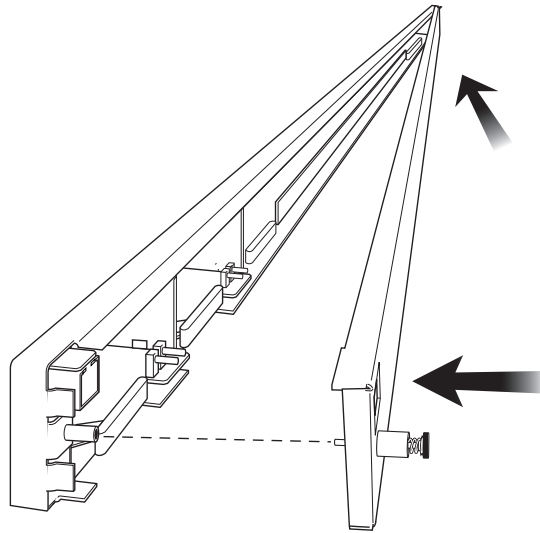

**Figure 2-11. Replacing or Installing Cards**



## Section 3 Configuration

### 1. INTRODUCTION

To configure the MX2800, use a 10Base-T Ethernet connection, a SLIP/PPP modem port, or a VT100 terminal. [Figure 3-1](#) shows the Configuration menu.

---

#### NOTE

A Telnet menu session has priority over a terminal menu session through the craft port. If a terminal menu session is active when a Telnet menu session is initiated, the terminal menu session will be disabled until the Telnet session is closed.

---

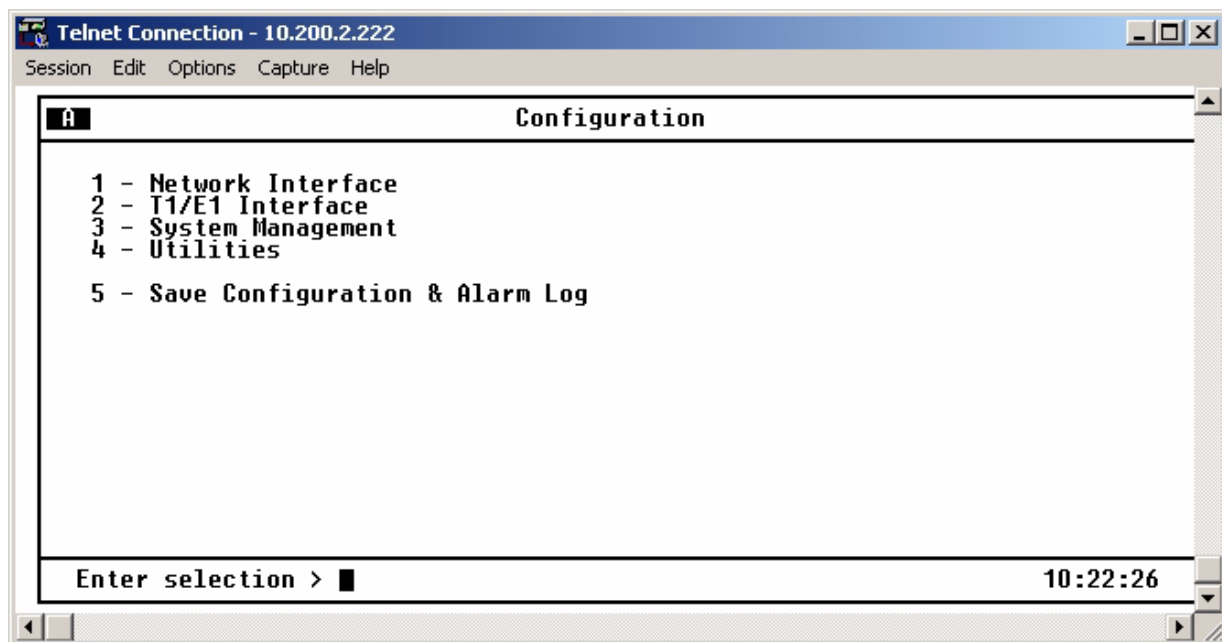

**Figure 3-1. Configuration Menu**

Detailed descriptions of the menu selections are given in the following subsections. The Configuration menu provides the following five submenus:

- [Network Interface](#) on page 3-4

- *TI/EI Interface* on page 3-8
- *System Management* on page 3-16
- *Utilities* on page 3-38
- *Save Configuration and Alarm Log* on page 3-44

**Figure 3-2** on page 3-3 shows the Configuration menu tree.

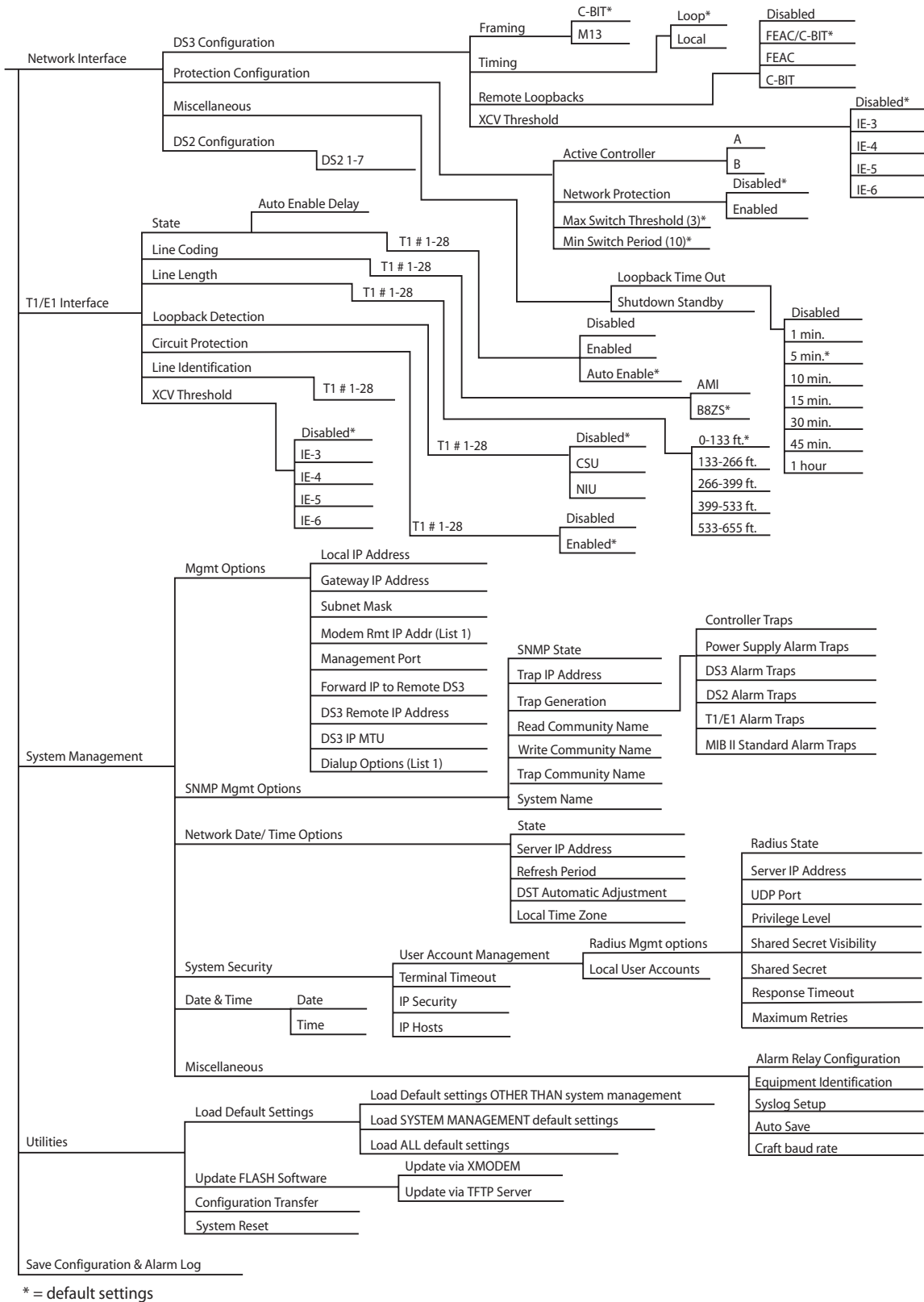

Figure 3-2. Configuration Menu Tree

## 2. NETWORK INTERFACE

Select Network Interface to access the network configuration parameters. See [Figure 3-3](#). Configure the MX2800 network settings to match the DS3 signal received from the service provider.

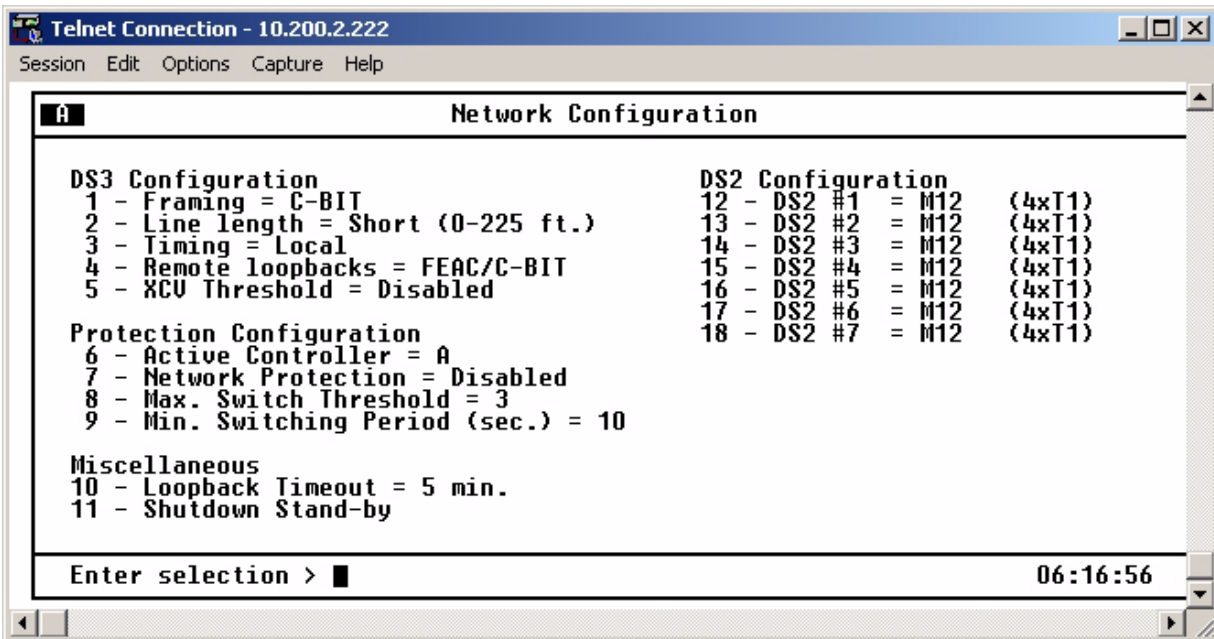

Figure 3-3. Network Configuration Menu

### DS3 Configuration

The DS3 Configuration selections are used to configure the DS3 network settings to match the desired application. Descriptions of these settings are explained below.

#### Framing

The framing format is used to match the format of the receive signal at the network interface. The MX2800 supports C-bit and M13 framing formats.

---

#### NOTE

M13 may not be selected when IP Forwarding is active.

---

#### Line Length

The line length is set to reflect the physical length of the DS3 network line.

- Long should be used if the cabling distance exceeds 225 feet.
- Short should be used if the distance is less than 225 feet.

---

**NOTE**

First and second generation DS3 controller cards (P/N 1200288Lx and P/N 1202288Lx) use Long for distances over 50 feet and Short for distances under 50 feet.

---

---

**NOTE**

Fifth generation DS3 controller cards (P/N 1205288Lx) do not require a DS3 line length setting; therefore, Line Length does not appear as a menu item.

---

## Timing

When the MX2800 is connected to a network that provides timing, configure the MX2800 for LOOP timing to derive timing from the network. If the MX2800 is the master timing source for the circuit, configure the MX2800 to LOCAL. In applications where two MX2800s are connected back-to-back with an un-channelized DS3, configure one MX2800 to LOOP and one MX2800 to LOCAL.

## Remote Loopbacks

The following four options are available for remote loopbacks:

- FEAC/C-BIT is used to allow the MX2800 to respond to remote loopback requests received over either the DS3 Far End Alarm and Control (FEAC) channel and/or DS2-level C bits. This mode is valid in both C-BIT and M13 framing formats.
- FEAC is used to allow the MX2800 to respond only to remote loopback requests received over the DS3 FEAC channel. This mode is valid only when using C-BIT framing. In this mode, DS2 C-bit loopbacks will be ignored.
- C-BIT is used to allow the MX2800 to respond only to remote loopback requests received over DS2 C bits. This mode is available when operating in either C-BIT or M13 framing. In this mode, FEAC loopbacks received when operating in C-BIT framing will be ignored.
- Disabled is used to ignore all out-of-band loopback requests (FEAC and DS2 C-BIT). When Disabled is selected, the MX2800 will still respond to individual T1 in-band CSU/NIU loopbacks if so configured in the T1/E1 Loopback Detection menu.

---

**NOTE**

Choose FEAC/C-BIT via menus in either C-BIT or M13 framing modes; however, there is no FEAC channel when framing is set to M13. Therefore, no DS3 far end alarms or loopback requests via the FEAC will be valid when the MX2800 is configured for M13.

---

## XCV Threshold

Excessive code violations (XVC) Threshold sets a limit on CVs accepted by the unit before it switches controller cards. If set to Disabled, code violations will not cause the unit to switch controller cards. The threshold limits are described in [Table 3-1](#).

**Table 3-1. XCV Threshold Limits**

Setting	The unit switches controller cards if...
1E <sup>-3</sup>	More than one out of every 1,000 bits received on the DS3 contains a code violation
1E <sup>-4</sup>	More than one out of every 10,000 bits received on the DS3 contains a code violation
1E <sup>-5</sup>	More than one out of every 100,000 bits received on the DS3 contains a code violation
1E <sup>-6</sup>	More than one out of every 1,000,000 bits received on the DS3 contains a code violation

## Protection Configuration

The MX2800 houses two controller cards for 1:1 protection against hardware failure. The two cards can also provide network protection, supporting two T3 circuits simultaneously. The selections in this menu allow customizing the unit's protection setup.

### Active Controller

This field displays A or B, indicating the active controller card. This setting can be used to force the controller cards to switch. For example, if controller card A is active and B is selected, a switch-over occurs immediately.

### Network Protection

This field enables or disables the unit's ability to automatically route information to the backup T3 in the event of a primary T3 failure. If enabled, all information is automatically routed to the backup T3. If disabled, the stand-by controller protects against failures of the active controller.

### Maximum Switch Threshold

The value entered in this field determines the number of times per hour the unit is allowed to switch between controller cards. If, in an hour, the cards switch more than the Maximum Number of Switches, the unit issues a trap and stops switching cards for the next 24 hours. Refer to [Trap Descriptions](#) on page 3-22. The default setting is three times an hour. This count may be cleared by clearing Protection Switch alarm counts. See [Figure 5-13](#) on page 5-14.

### Min. Switching Period

After the unit switches controller cards, the number of seconds entered in this field must pass before another card switch will be allowed. The default setting is 10 seconds.

## Miscellaneous

The Miscellaneous menu selections are used to configure the Loopback Timeout and Shutdown Stand-by settings. Descriptions of these settings are explained below.

### Loopback Timeout

The Loopback Timeout option is used to set the loopback timeout to one of the following:

- Disabled
- 1 min.
- 5 min.
- 10 min.
- 15 min.
- 30 min.
- 45 min.
- 1 hr.
- 120 min.

### Shutdown Stand-By

The Shutdown Stand-by option causes the system to disable the standby controller card, thus making it unavailable for protection switches. Once this option has been selected and the standby controller has been shut down, the option changes to Reset Stand-by. Selecting this option resets and reactivates the standby controller, thus making it available for protection switching.

## DS2 Configuration

The MX2800 can individually frame each of the seven DS2 streams in M12 (four T1s) or G.747 (three E1s) format. When set to M12 (4xT1), the four T1s for the selected group are framed per ANSI T1.107. When set to G.747 (3xE1), the first three T1/E1 ports of the selected group are framed per CCITT G.747 into the DS3 stream. The fourth T1/E1 port of the selected group is not available in this mode. Any combination of M12 (4xT1) and G.747 (3xE1) is allowed.

### 3. T1/E1 INTERFACE

The T1/E1 Interface menu, see [Figure 3-4](#), is used to activate/deactivate individual T1s and E1s and to set their line coding, length, loopback detection, circuit protection, and line ID string. The T1/E1 code violation threshold is also configured through this menu. Configuration selections are described in the following sections.

---

#### NOTE

A DS2 can be divided into either three E1s or four T1s. Therefore, when dealing with an E1 configuration, some of the fields in the T1/E1 Interface menus do not apply (and therefore display N/A).

---

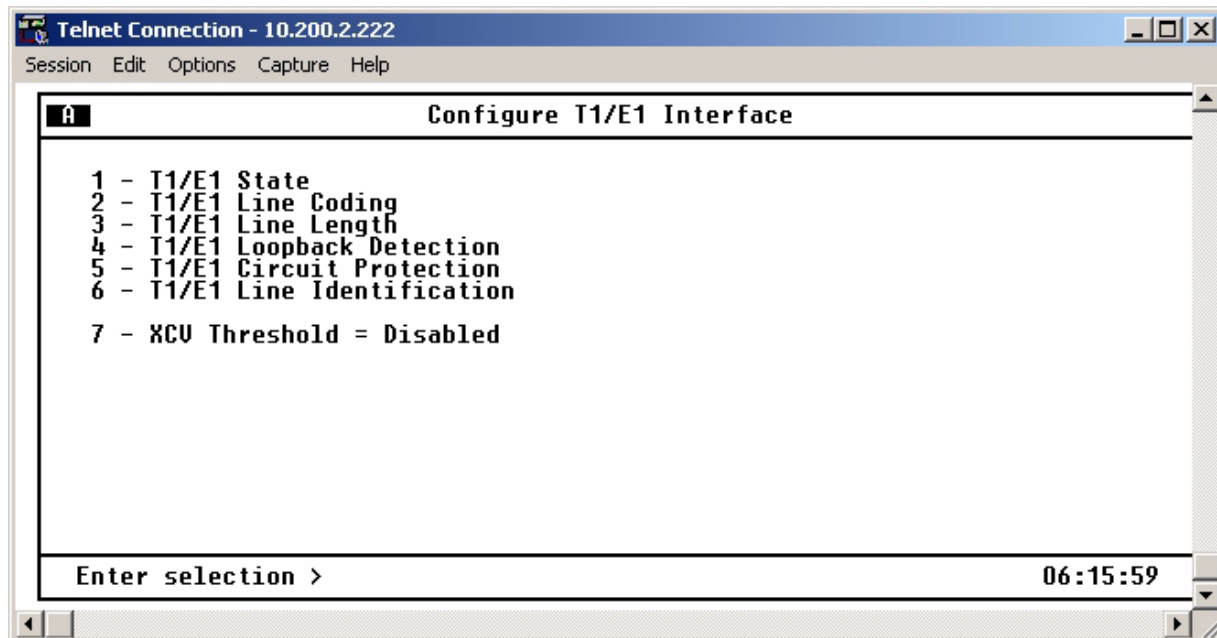

Figure 3-4. T1/E1 Interface Menu



## T1/E1 State

The T1/E1 lines are set to Disabled, Enabled, or Auto Enable. In Auto Enable, the port is not fully enabled (and alarms are not issued) until a T1/E1 signal is detected on that port's receiver for a specified period of time. See [Figure 3-5](#) on page 3-9. This period of time is set by the Auto Enable Delay option. The options are as follows:

- 2 seconds (default)
- 1 hour
- 2 hours
- 12 hours
- 1 day
- 2 days
- 7 days

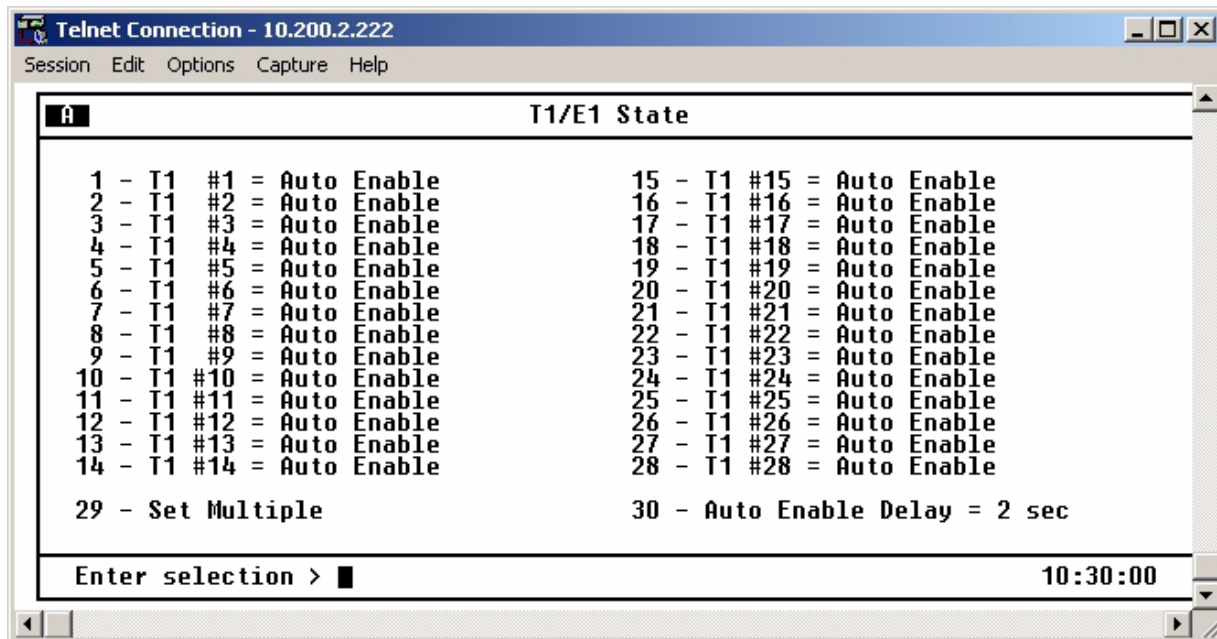

Figure 3-5. T1/E1 State Menu

## Set Multiple

The Set Multiple, see [Figure 3-6](#) on page 3-10, option is used to enable or disable a contiguous group or all of the T1/E1s at one time. To enable or disable all T1/E1s, set First to 1 and Last to 28. Enter Apply settings before leaving the menu. To enable or disable only some of the T1/E1s, set First and Last to correspond to the desired lines. Enter Apply settings. Either leave the menu at this point or continue to enter new First and Last numbers for other lines.

---

**NOTE**

Settings should be applied following each change.

---

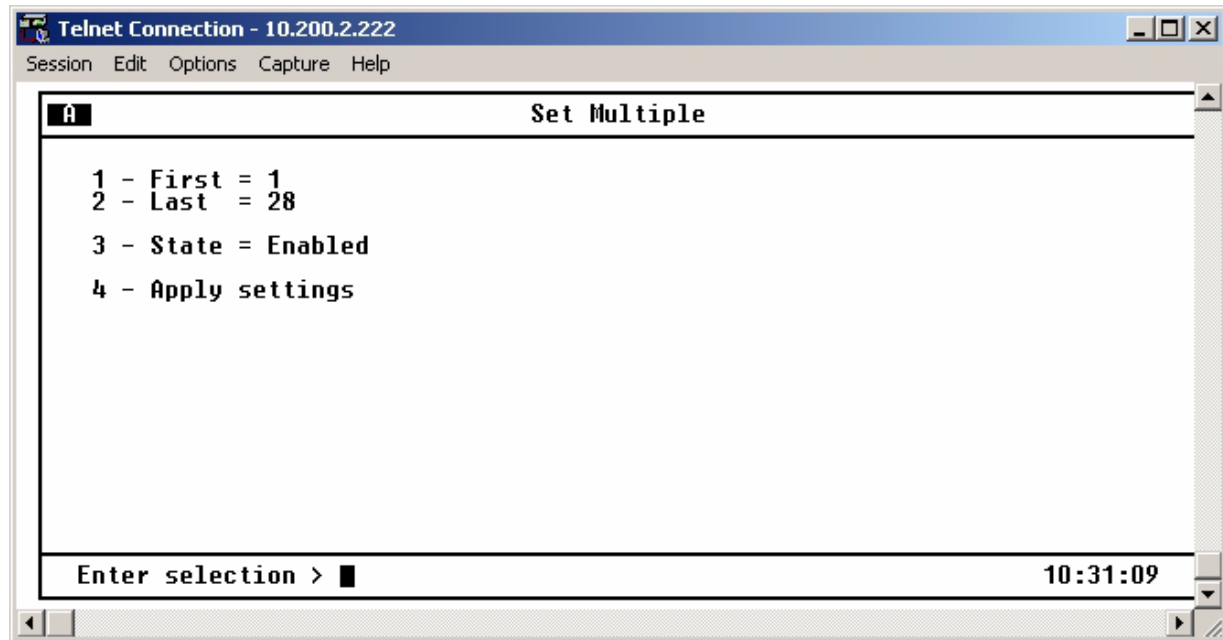

Figure 3-6. Set Multiple Menu

## T1/E1 Line Coding

Set the line code for each individual T1/E1 interface to match the connected device. See [Figure 3-7](#) on page 3-11. The choices available for T1 are AMI and B8ZS. The choices available for E1 are AMI and HDB3. Select Set Multiple to set a contiguous group or all of the T1s (or E1s) to the same value at the same time. Refer to [Set Multiple](#) on page 3-9 for a description of the Set Multiple option.

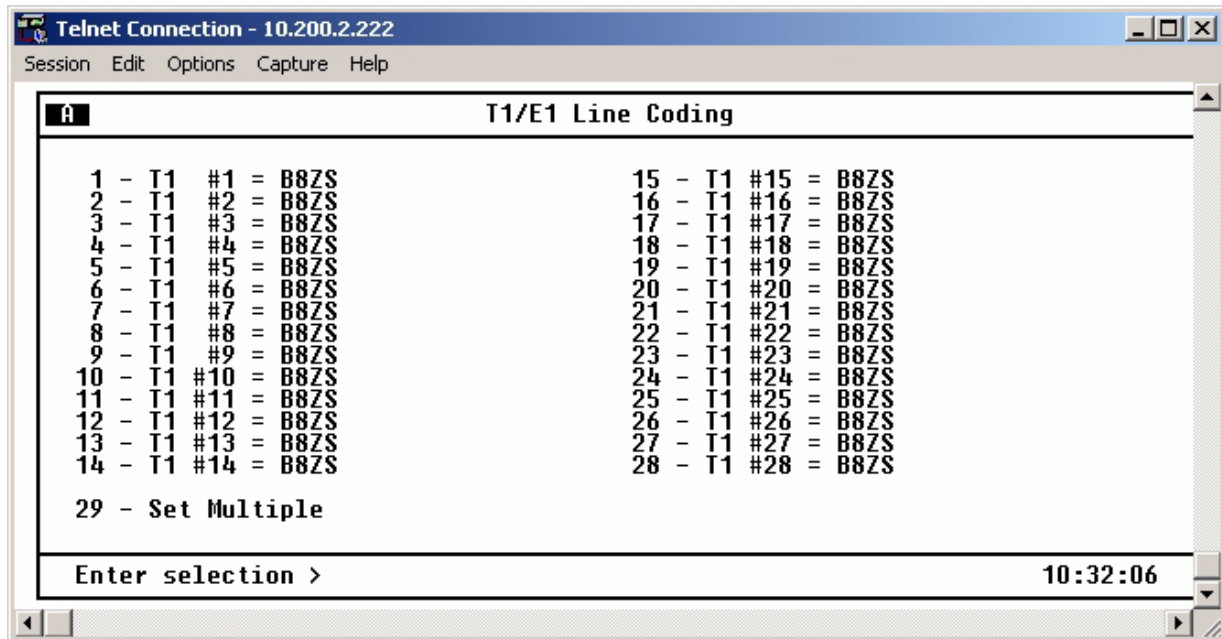

Figure 3-7. T1/E1 Line Coding Menu

## T1/E1 Line Length

Set the line length for each T1 interface according to the distance from the MX2800 to the connecting DSX termination. See [Figure 3-8](#) on page 3-12. The E1 Line Length is not selectable and remains at 0-6 dB loss. Select Set Multiple to configure the line length for a contiguous group or all of the T1s to the same length at the same time. Refer to [Set Multiple](#) on page 3-9 for a description of the Set Multiple option.

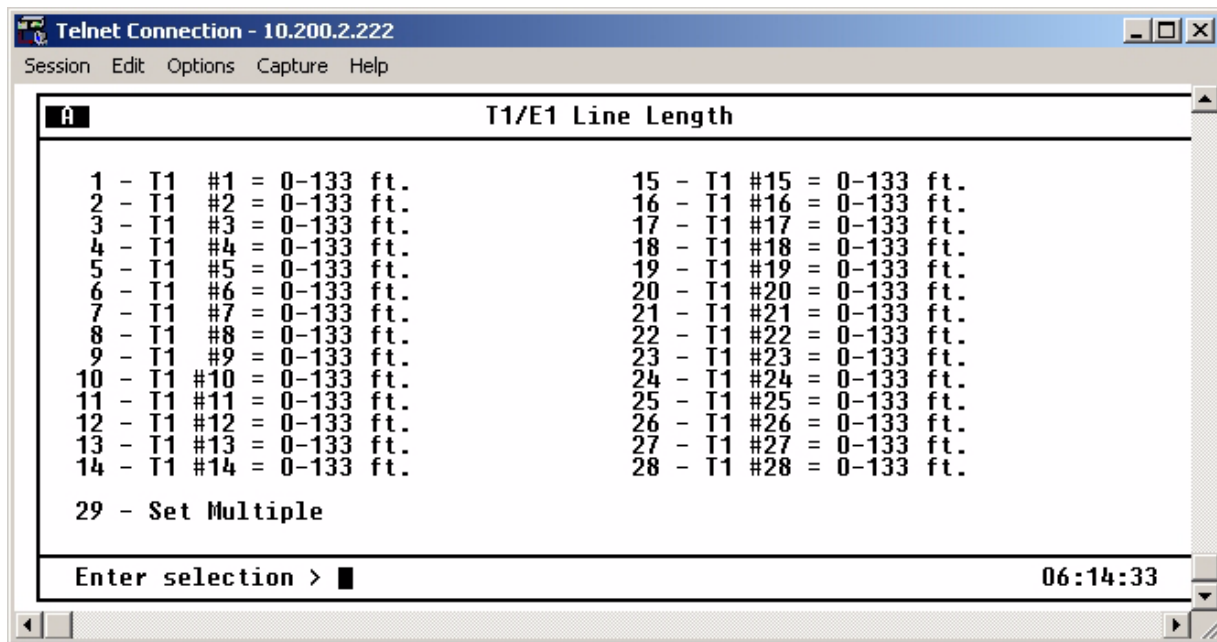

Figure 3-8. T1/E1 Line Length Menu

## T1/E1 Loopback Detection

The T1/E1 Loopback Detection option is used to set how the T1/E1 lines respond to loopback requests coming from the network. See [Figure 3-9](#) on page 3-13.

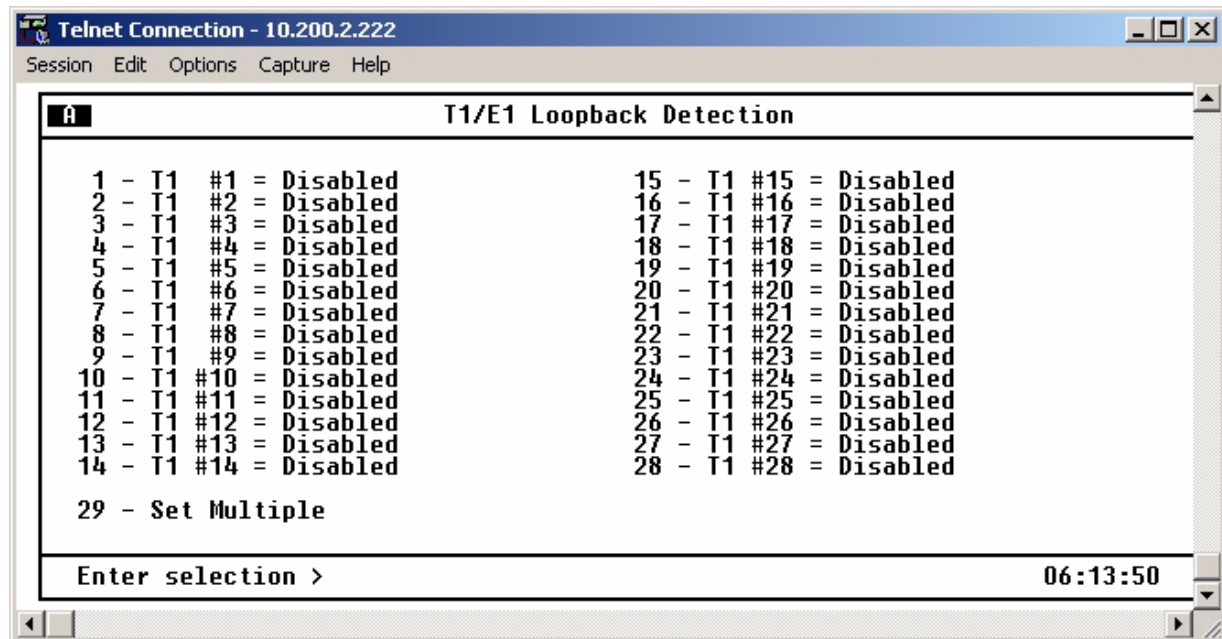

Figure 3-9. Loopback Detection Menu

The following options are available for detection:

- Disabled is used to cause the T1/E1 lines to ignore in-band loop-up and loop-down codes.
- CSU is used to cause the channel to loop up or loop down when it receives a CSU loop-up or loop-down pattern for more than 5 seconds.
- NIU is used to cause the channel to loop up or loop down when it receives an NIU loop-up or loop-down pattern for more than 5 seconds.

Select Set Multiple to set a contiguous group or all of the T1/E1s to the same value at the same time. Refer to [Set Multiple](#) on page 3-9 for a description of the Set Multiple option.

## T1/E1 Circuit Protection

T1/E1 Circuit Protection determines which circuit is allowed to initiate a protection switch if a failure in the circuitry for that channel is detected. See [Figure 3-10](#) on page 3-14. If a T1/E1 is set to Disabled, the failure of the circuitry of that one channel does not cause a protection switch. If set to Enabled, the failure of a channel causes a protection switch to occur if the Protection Threshold setting in this menu is exceeded.

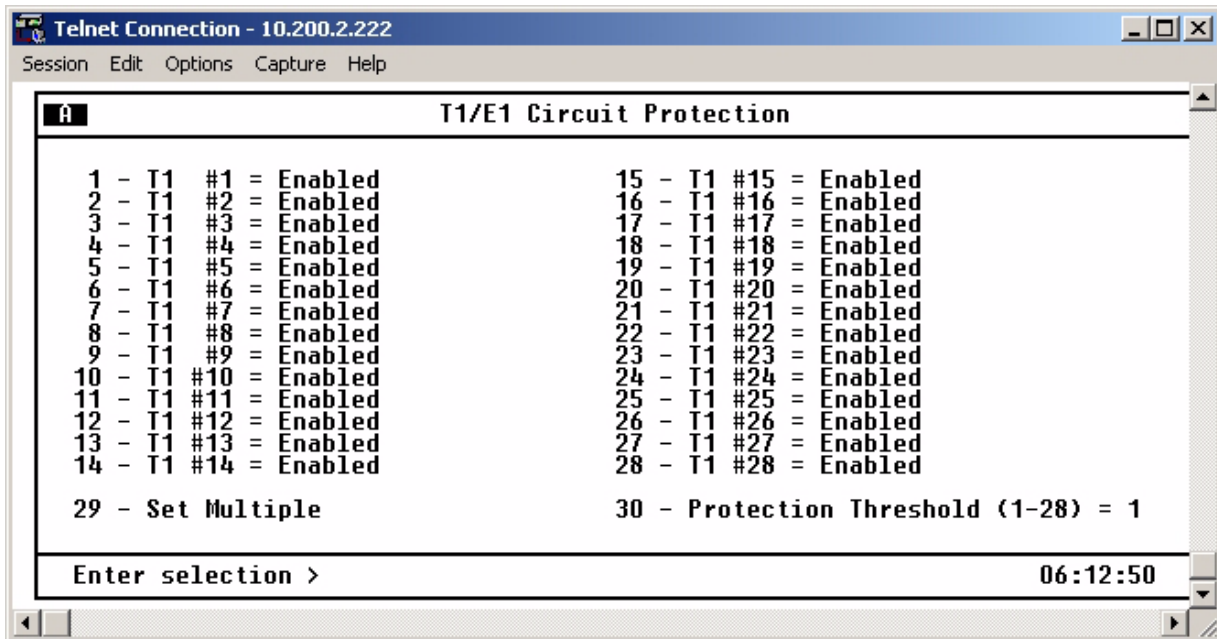

**Figure 3-10. Circuit Protection Menu**

The Protection Threshold setting determines how many of the Enabled lines must fail before a card switch occurs. If the failure of a single protected (enabled) line is to cause a card switch, set the Protection Threshold to 1. Choices include 1 through 28.

Select Set Multiple to set a contiguous group or all of the T1/E1s to the same value at the same time. Refer to [Set Multiple](#) on page 3-9 for a description of the Set Multiple selection.

## T1/E1 Line Identification

This field is used to enter user-configurable text strings to name the individual T1/E1 lines. See [Figure 3-11](#) on page 3-15. This field will accept up to 18-alphanumeric characters, including spaces and special characters.

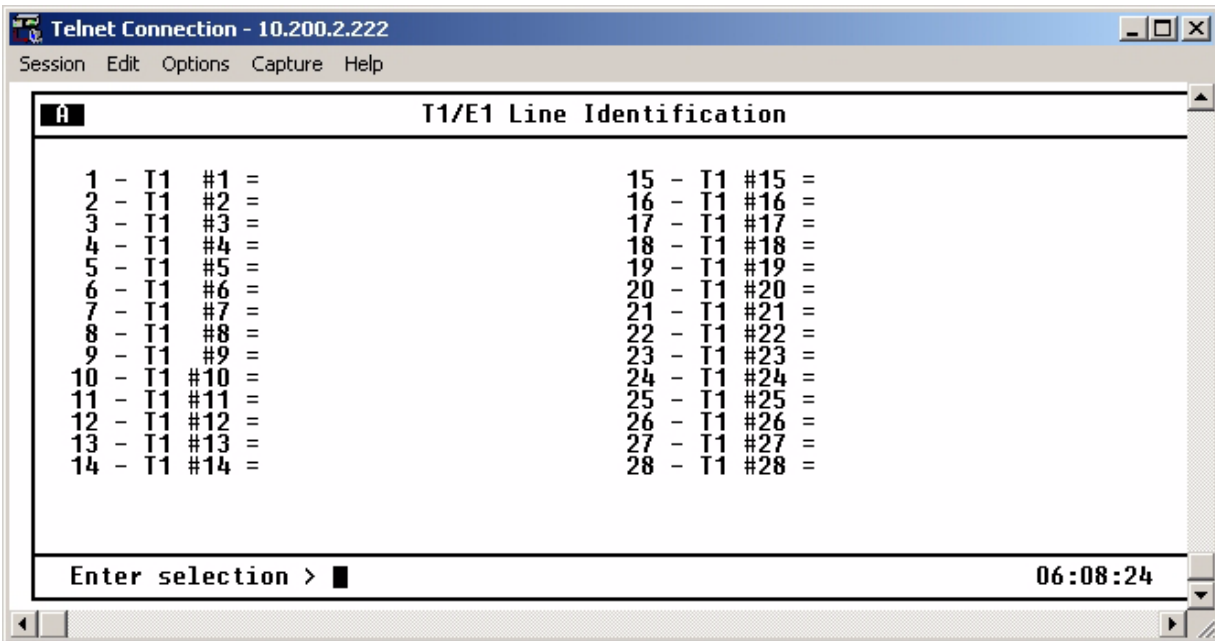

Figure 3-11. Line Identification Menu

## XCV Threshold

This value sets a limit on excessive code violations (ECVs) accepted by the unit over an individual T1/E1 line before it switches controller cards. If set to Disabled, code violations will not cause the unit to switch controller cards. The threshold limits are described in [Table 3-2](#).

Table 3-2. XCV Threshold Limits for T1/E1

Setting	The unit switches controller cards if...
1E <sup>-3</sup>	More than one out of every 1,000 bits received on a T1/E1 line contains a code violation
1E <sup>-4</sup>	More than one out of every 10,000 bits received on a T1/E1 line contains a code violation
1E <sup>-5</sup>	More than one out of every 100,000 bits received on a T1/E1 line contains a code violation
1E <sup>-6</sup>	More than one out of every 1,000,000 bits received on a T1/E1 line contains a code violation

## 4. SYSTEM MANAGEMENT

Configure the MX2800 for management through SNMP, Telnet, or a VT100 interface. See [Figure 3-12](#) on page 3-16. Embedded SNMP and Telnet are available via a SLIP/PPP modem port or 10Base-T Ethernet interface. This menu also includes options used to customize the unit's alarm and trap generation, security setup, and equipment identification. The fields of the System Management Configuration menu vary depending upon the configuration of the options in the shelf.

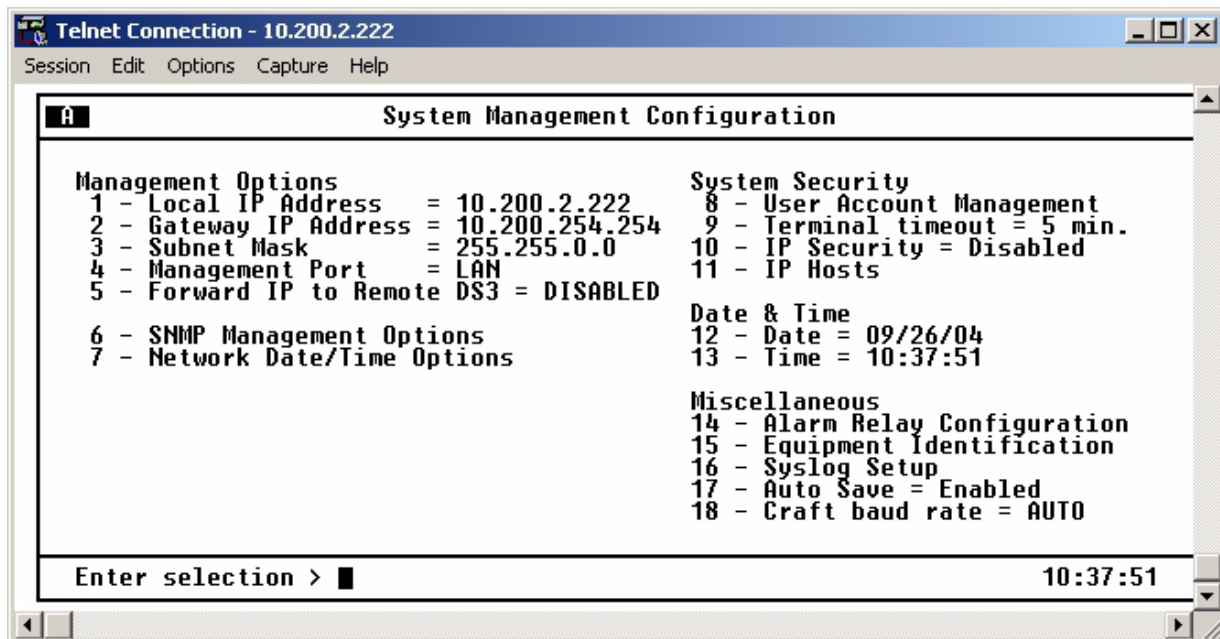

**Figure 3-12. System Management Configuration Menu**

---

### CAUTION

Configuration changes to Local IP Address, Gateway IP Address, Subnet Mask, and IP Hosts will not be implemented unless all Telnet sessions are closed. Changes made while Telnet sessions are active will invoke a warning message on the console.

---



---

### NOTE

If the unit is not equipped with an internal modem, Dialup Option will not be available.

---



## Management Options

The Management options sets the fields that allow SNMP, Telnet, or VT100 interface access. The options are listed below.

### Local IP Address

This field is used to enter the MX2800 IP address. This IP address applies to the LAN or modem port when configured for SLIP/PPP. This address is available from a network administrator.

### Gateway IP Address

This field is used to enter the gateway IP address of the MX2800. This address is necessary only if the MX2800 and the network manager are connected through a gateway node. If an IP packet is to be sent to a different network, the unit sends it to the gateway.

### Subnet Mask

This field is used to enter the subnet mask of the MX2800. This address is available from a network administrator.

### Modem Remote IP Address

This field is used to enter the IP address of a server that accesses the MX2800 via a modem over PPP or SLIP. This option is available only if the Management Port is set to LAN + MODEM or DS3 + MODEM.

### Management Port

This field is used to assign the management port as either LAN, MODEM, LAN+MODEM, DS3, or DS3+MODEM. The Modem setting applies only to units equipped with an internal modem.

### Forward IP to Remote DS3

This field is used to enable or disable the IP forwarding feature that allows IP access to a remote MX2800 across the DS3 channel. With this feature, the far-end MX2800 appears as if it is on the same LAN as the near-end MX2800. To access any IP related feature on the far-end unit, address packets to the IP address of the far-end unit.

---

#### NOTE

If the near-end and far-end MX2800s are currently on the same LAN, it is important to configure the far-end MX2800 Management Port option for DS3 or DS3 + MODEM before enabling Forward IP To Remote DS3 on the near-end unit. Doing so prevents multiple MAC addresses from being associated with the same IP address in the networks ARP tables.

---

---

**NOTE**

The DS3 must be up and running error-free and using C-Bit framing (this feature will not work with M13 framing). The Management Port option for the near-end unit (one connected to the Ethernet LAN) must be set to either LAN or LAN + MODEM. A valid IP Address, Subnet Mask, and Default Gateway must be entered for the near-end unit.

---

**DS3 Remote IP Address**

If Forward IP to Remote DS3 is Enabled, set the DS3 Remote IP Address to a valid IP address on the same subnet as the near-end unit. All packets that are sent to this IP address will be forwarded across the DS3 channel to the far-end unit.

---

**NOTE**

The IP Address of the remote unit must be the same as the one that is entered for the DS3 Remote IP Address in the near-end unit's menus. The Management Port option for the far-end unit must also be set to DS3 or DS3+MODEM to be managed remotely over the DS3. The Subnet Mask and Default Gateway do not need to be set in the far-end unit's menus. The DS3 Remote IP Address must be on the same subnet as the Local IP Address.

---

**DS3 IP MTU**

This field is used to select the maximum IP datagram size (in bytes) for the IP forwarding link over the DS3. This option should be left at its default and preferred value of 260. If and only if the device on the other side of the DS3 facility is an ADTRAN device that also has this option, then both sides can be set to 1500 to avoid fragmentation of large packets. Otherwise, leave the setting at 260 to avoid lost packets.

**Dialup Options**

This field is used to configure the dialup capabilities of the MX2800. See [Figure 3-13](#). These options apply only to units equipped with an internal modem.

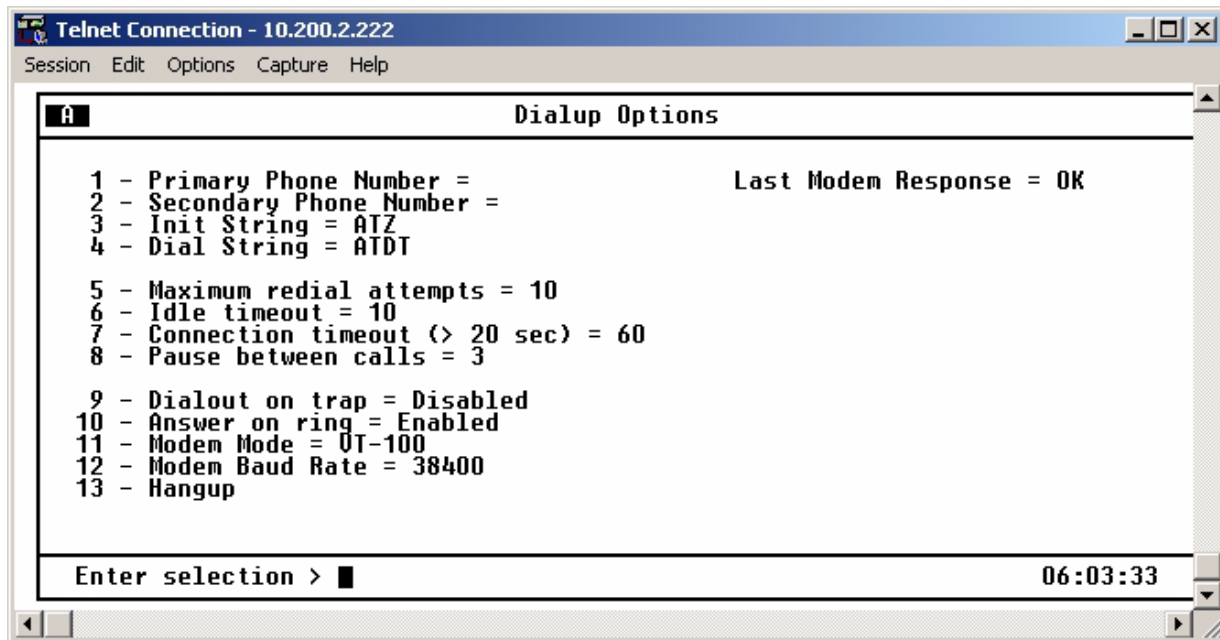

Figure 3-13. Dialup Options Menu

### Primary and Secondary Phone Numbers

When the MX2800 dials out to send a trap, it first dials the Primary Phone Number. If the call is unsuccessful, it tries the Secondary Phone Number. Attempts between the two numbers continue until a call is established and the trap is reported (or until each number's maximum for redial attempts is reached). Refer to [Maximum Redial Attempts](#) on page 3-19.

### Initializing String

The AT command entered in this field is used to initialize the modem. Normally, this field should be left at the default setting (ATZ).

### Dial String

The AT command entered in this field causes the modem to dial out. Normally, this field should be left at the default setting (ATDT).

### Maximum Redial Attempts

The MX2800 attempts to establish a call the number of times entered in this field. If a successful call is not established after the final attempt, the MX2800 discards the trap messages.

### Idle Timeout

After establishing a call and sending trap messages, the MX2800 remains online for the amount of seconds entered in this field. If the field is set to 0, the unit hangs up as soon as the trap is sent.

**Connection Timeout**

The MX2800 waits for a connection for the number of seconds entered in this field. Timing begins as soon as the dial command is issued. This field must be set for greater than 20 seconds.

**Pause Between Calls**

The MX2800 waits between redial attempts for the number of seconds entered in this field.

**Dialout On Trap**

This field is used to enable or disable the MX2800's ability to dial out to report traps. Modem Mode configured for VT-100 reports error conditions in plain ASCII with the following information:

- The Unit ID value programmed in the Equipment Identification portion of the System Management screen. Refer to *System Management* on page 3-16.
- A trap code indicating the error condition
- A text description of the fault
- The date and time when the error was logged

When Modem Mode is configured for PPP or SLIP, the MX2800 logs into the PPP/SLIP host and reports the error conditions to the hosts designated under Trap IP Addresses. Refer to *Trap IP Addresses* on page 3-21.

**Answer on Ring**

This option enables or disables the MX2800's ability to accept incoming calls. If enabled, incoming calls are automatically answered by the MX2800, allowing remote performance of management functions.

**Modem Mode**

This field is used to select the Modem port function for the desired application (VT-100, PPP, or SLIP). The Modem port, located on the rear panel of the MX2800, provides a telephone line (POTS) for connection to the internal V.34 modem. This setting applies only if the Management Port is set to Modem. Refer to *Management Port* on page 3-17.

**Modem Baud Rate**

This option is used to set the maximum operating speed in bps of the Modem port:

- 1200
- 2400
- 4800
- 9600
- 19200
- 38400

**Hangup**

Selecting this option forces the MX2800 to end an established call.

**Last Modem Response**

This status field displays the last modem response to the MX2800. Possible responses are as follows:

- OK
- Connect
- Busy
- Error
- No Dialtone
- No Carrier

**SNMP Management Options****SNMP State**

Use this menu to Enable or Disable SNMP for the MX2800. When disabled, the MX2800 ignores all incoming SNMP packets and does not transmit SNMP packets.

**Trap IP Addresses**

This field is used to enter up to five IP addresses of SNMP managers to which the MX2800 sends traps.

**Trap Generation**

Use this menu, see [Figure 3-14](#), to designate which error conditions cause the unit to send trap messages.

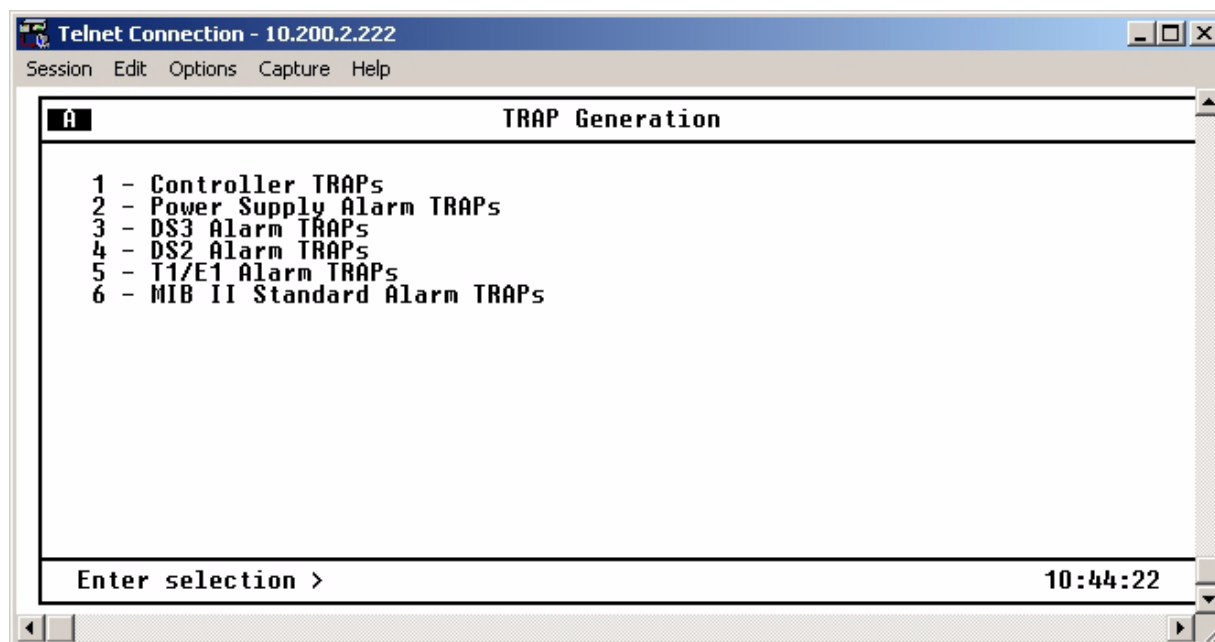

Figure 3-14. Trap Generation Menu

Table 3-3 provides trap descriptions.

Table 3-3. Trap Descriptions

Trap	If enabled, the unit issues a trap when...
<b>Controller Traps</b>	
Protection Switch	The controller cards switch.
Card Removed	A controller card has been removed.
Card Failure	A controller card has failed.
Communication Fail	The controller cards can no longer communicate with each other.
Max Switches	The Max Switch Threshold is reached. For more information, refer to <a href="#">Maximum Switch Threshold</a> on page 3-6.
<b>Power Supply Alarm Traps</b>	
Card Removed	The power supply card has been removed.
Malfunction	The power supply card is no longer working and the unit has switched to the backup power supply or battery backup.
Card Failure	The power supply card has failed.
Power Low	The power supply's output level is abnormally low.
Bat. Backup Act	Battery charger has lost its AC power source.

**Table 3-3. Trap Descriptions (Continued)**

<b>Trap</b>	<b>If enabled, the unit issues a trap when...</b>
Battery Low	Battery backup has reached an energy point insufficient to supply the unit with power.
Temperature High	The power supply card is getting too hot.
Temperature Critical	The power supply card temperature is so high that it may suffer damage.
<b>DS3 Alarm Traps (Near-End Active and Standby Cards)</b>	
LOS	The controller card has lost the network Rx signal.
OOF	The controller card detects a framing loss from the network.
AIS	The controller card is receiving an AIS (blue) alarm condition from the network. AIS alarms occur when consecutive 1010s are received in the information bits. This indicates that  The controller card is receiving an AIS (blue) alarm condition from the network. This alarm occurs when consecutive 1010s are received in the information bits, indicating there is a transmission fault located either at or upstream from the transmitting terminal.
RAI	The controller card is receiving an RAI (yellow) alarm from the network. This alarm is a signal sent back toward the source of a failed transmit circuit. The X-bits (X1 and X2) are set to zero.
IDLE	The controller card detects an idle sequence from the network.
TX LOS	The controller card's transmitter has failed.
XCV	The controller card is receiving excessive code violations, exceeding the threshold set by the user. For more information, refer to <i>XCV Threshold</i> on page 3-6.
In/Out Test	The DS3 is going in and out of test (applies to the Active controller card only).
<b>DS3 Alarm Traps (Far-End Active Cards)</b>	
LOS	The remote unit's active controller card has lost the network Rx signal.
OOF	The remote unit's active controller card detects a framing loss from the network.
AIS	The remote unit's active controller card is receiving an AIS (blue) alarm condition from the network.
RAI	The remote unit's active controller card is receiving an RAI (yellow) alarm from the network. This alarm is a signal sent back toward the source of a failed transmit circuit. The X-bits (X1 and X2) are set to zero.
IDLE	The remote unit's active controller card detects an idle sequence from the network.
DS3 Eqpt Fail SA	The remote unit's active controller card is receiving a service-affecting equipment failure message from the network.
DS3 Eqpt Fail NSA	The remote unit's active controller card is receiving a non-service-affecting equipment failure message from the network.

**Table 3-3. Trap Descriptions (Continued)**

<b>Trap</b>	<b>If enabled, the unit issues a trap when...</b>
Comn Eqpt Fail NSA	The remote unit's active controller card is receiving a common equipment failure message from the network.
<b>DS2 Alarm Traps</b>	
OOF	The DS2 detects a framing loss from the network.
AIS	The DS2 is receiving an AIS (blue) alarm condition from the network. AIS alarms occur when the unit is receiving unframed all ones.
RAI	The DS2 is receiving an RAI (yellow) alarm from the network. This alarm is a signal sent back toward the source of a failed transmit circuit. The X-bit is set to zero.
<b>Local T1/E1 Alarm Traps</b>	
LOS	The unit has lost the Rx signal on a T1/E1.
carrier side AIS (CAIS)	The T1 is receiving all ones from the DS3 side of the network.
loop side AIS (LAIS)	The T1 is receiving all ones from the DSX-1 interface.
XCV	The unit is receiving excessive code violations across a T1/E1, exceeding the configured threshold. For more information, refer to <i>XCV Threshold</i> on page 3-15.
T1/E1 Failure	A T1/E1 has failed.
In/Out Test	A T1/E1 is going in or out of test.
<b>Far-End Alarms (available only in C-Bit Parity mode)</b>	
Multiple DS1 LOS	The far-end equipment has lost multiple T1/E1 lines.
Single DS1 LOS	The far-end equipment has lost a single T1/E1.
DS1 Eqpt Fail SA	A service-affecting equipment failure is being reported by the far-end.
DS1 Eqpt Fail NSA	A non-service-affecting equipment failure is being reported by the far-end.
<b>MIB II Standard Alarm Traps</b>	
Cold Start	The unit is first powered up.
Link Up	The DS3 is up with no alarms.
Link Down	The DS3 is in alarm.
Authentication Failure	An attempt has been made by an unauthorized user to access the unit.

### Read Community Name

This field is used to enter the authentication strings used for SNMP management. Match the MX2800 to the SNMP manager for read privileges.



### **Write Community Name**

This field is used to enter the authentication strings used for SNMP management. Match the MX2800 to the SNMP manager for write privileges.

### **Trap Community Name**

This field is used to enter the identification string used for trap management. This string accompanies all traps transmitted by the MX2800.

### **System Name**

This value is equivalent to the sysName item defined in RFC1213. The value is an administratively-assigned name for the managed node. By convention, this is the node's fully-qualified domain name.

### **Network Date/Time Option**

The MX2800 is capable of having the date and time provisioned from a remote server using one of two supported protocols: SNTP version 3 (per RFC1769) and Network Time (per RFC868).

Several options are available for provisioning this feature, all of which are accessible only via menus by users with Admin-level privileges. These options reside in the System Management menu.

### **State**

This option sets the mode or protocol used to retrieve the date and time from the server. Possible values are Disabled, SNTP, and Net Time. When the State option is set to Disabled, the user should explicitly set the date and time locally (via menus, TL1, or SNMP). If the State option is set to SNTP or Net Time, then the product prevents any attempt to set the time locally. The default value is Disabled.

### **Server IP Address**

This option sets the IP address of the server to be queried for the date and time.

### **Refresh Period**

This option sets the length of time between queries to the server. The available values range are as follows:

- 1 minutes interval
- 5 minutes interval
- 10 minutes interval
- 15 minutes interval (default)
- 20 minutes interval
- 25 minutes interval
- 30 minutes interval
- 35 minutes interval

- 40 minutes interval
- 45 minutes interval
- 50 minutes interval
- 55 minutes interval
- 60 minutes interval

### **DST Automatic Adjustment**

This option sets automatic adjustment for North American daylight saving time. Available values are Enabled and Disabled. The default value is Enabled. This automatic adjustment is performed only in association with responses from the server. The automatic adjustment does not take place if the State option is disabled and/or if the server cannot be contacted.

### **Local Time Zone**

This option sets the time zone in which the MX2800 unit is located. Possible values consist of North American time zones from Hawaii-Aleutian Standard Time to Atlantic Standard Time. The default value is Eastern Standard Time.

---

#### **NOTE**

The MX2800 processes only the Transmit Timestamp value of all SNTP response messages. Other constructs supported by the protocol (such as root delay, root dispersion, authentication, etc.) are not processed by the MX2800.

---

## **System Security**

### **User Account Management**

This option is used to enter up to 15 user accounts. Each user account is assigned a username, password, and privilege level. Usernames and passwords are not case sensitive but must be 12 characters or less. Each user account is assigned a privilege level to provide the option of limiting a user's access to the MX2800. The four privilege levels are listed below.

#### **Guest**

A user with this read-only privilege level can view almost all menu items on the console interface menus and can perform a limited number of TL1 commands, none of which can alter the product's configuration.

#### **Interface**

A user with write-access privilege level can configure items related to the network interface and T1/E1 interface but can not initiate loopbacks and view and/or alter several system-level items such as LAN configurables.

### Test

A user with write-access privilege level can configure the network interface and T1/E1 interface and can initiate loopbacks but may not view and/or alter several system-level items such as LAN configurables, etc.

### Admin

With Admin privilege level, all menu items can be viewed and/or altered. Only a user with an Admin user account can alter the User Account Management information.

User accounts provide access to the MX2800 for console interface sessions and TL1 sessions. [Table 3-4](#) on page 3-30 provides a summary of privileges.

---

#### NOTE

The Load Default Settings menu item that is located on the Configuration/Utilities menu resets the User Account Management table back to the factory default account **adtran/adtran/admin**.

---

## RADIUS Authentication

The MX2800 is capable of communicating with a RADIUS server for authentication of menu users and TL1 users. The RADIUS authentication support is implemented per RFC2865. User account information in the onboard user database will remain intact when the MX2800 is upgraded to support authentication via RADIUS.

Several options are available for provisioning RADIUS authentication features, all of which are accessible only via menus and by users with Admin-level privileges.

### RADIUS State

This option sets the RADIUS authentication capabilities as either Enabled or Disabled. The default value is Disabled.

When the RADIUS State value is Enabled, the following behavior applies when a user enters a username and password at the MX2800. The MX2800 first authenticates the username and password against the local user database. If local authentication succeeds, then access is granted to the MX2800 with the privilege level assigned for that account in the onboard database. Local authentication is considered successful if both the username and password are authenticated, regardless of the privilege level (including Disabled).

If local authentication does not succeed, then the username and password are authenticated against the RADIUS server. If the RADIUS authentication succeeds, then access to the MX2800 is granted with the RADIUS Privilege Level set by the user. If the RADIUS authentication does not succeed, which includes the case where the MX2800 does not receive a response from the server, then the user is denied access to the MX2800.

Regardless of whether the RADIUS State option is Enabled or Disabled at the MX2800, each user account that exists in the local user database may be assigned one of the defined privilege levels for the MX2800 (Disabled, Guest, Interface, Test, or Admin). Only a user with the Admin privilege level can access the local database and the RADIUS options.

Username and passwords stored in the local user database are each limited to 11 ASCII characters. Username and passwords authenticated via RADIUS may each have up to 63 ASCII characters.

When RADIUS authentication is disabled, safeguards are in place that will prevent an Admin-level user from deleting all Admin-level accounts in the onboard user database. When RADIUS authentication is enabled, an Admin-level user who was authenticated through RADIUS will be allowed to delete all of the onboard accounts. This will be allowed to avoid some potential security concerns.

Safeguards will exist that will prevent certain combinations of options involving RADIUS and the local user database that would effectively remove all means of accessing the MX2800 with Admin privileges.

The recovery mechanism for gaining access via the challenge password (ADTRANPLEASEHELP) is supported regardless of whether the RADIUS authentication option is enabled or disabled. When a user enters this password, the MX2800 issues a unique challenge sequence that requires a response provided by ADTRAN Tech Support for access to the unit.

Local user accounts and passwords for the MX2800 are not case-sensitive. However, case is preserved for both username and password when authenticating through RADIUS. The TL1 input message specification limits the characters that may be sent as part of a TL1 command, unless the string is enclosed in double quotes. This is important when RADIUS authentication is used for authenticating TL1 sessions. Passwords or usernames with special characters must be placed in double quotes in the ACT-USER command. If double quotes appear inside the TL1 username or password, each double quote character must be immediately preceded by the backslash character to avoid confusion with the double quotes surrounding the username or password.

The MX2800 supports Challenge response messages from the RADIUS server regardless of whether the login attempt is made via menu or TL1. If a Challenge response is received from the server, then the user is prompted for additional information. The nature of this additional information is application-dependent. When the Challenge response is received during an attempt to log in via TL1, then a PLNA TL1 response is returned to the user and the Challenge message is provided in the TL1 comment field.

### **Server IP Address**

This option sets the IP address of the server to be queried for authentication. The default value is a null IP address. One IP address is supported.

### **UDP Port**

This option sets the UDP port of the server. The default value is 1812.

### **Privilege Level**

This option sets a single privilege level that applies for all users that are granted access via remote authentication. The possible values are Disabled, Guest, Interface, Test, and Admin. The default value is Guest. Refer to the appropriate MX2800 documentation for explanations of these privilege levels.

### **Shared Secret Visibility**

This option sets the visibility of the Shared Secret value as displayed in the provisioning menu for RADIUS authentication options. The possible values are Visible and Invisible. When this option is set to Invisible, the Shared Secret value is masked with asterisk characters. The default value is Invisible.

**Shared Secret**

This option sets the shared secret that is used during the process of authenticating via the RADIUS server. This value is a case-sensitive ASCII character string that has a maximum length of 63 ASCII characters. The default value is a null string.

**Response Timeout**

This option sets the number of seconds the MX2800 will wait for a response before retransmitting the request.

**Maximum Retries**

This option sets the maximum number of retransmissions of an authentication request that the MX2800 will attempt in the absence of a response from the server.

**Table 3-4. Console Menu User Privileges**

Console Menu Item	Privilege level(s) under which a user may alter (and in some cases, view) this item			
	Guest	Interface	Test	Admin
<b>Status Menu</b>				
Acknowledge alarms		X	X	X
<b>Statistics Menus</b>				
Clear statistics (for all Statistics menus)		X	X	X
Reset alarm log		X	X	X
<b>Configuration – Network Interface Menu</b>				
DS3 framing mode		X	X	X
DS3 line length (L1 Controller Card only)		X	X	X
DS3 timing		X	X	X
DS3 loopback detection		X	X	X
DS3 XCV threshold		X	X	X
Active controller		X	X	X
Network protection		X	X	X
DS3 max switch threshold		X	X	X
DS3 min switching period		X	X	X
Loopback time out		X	X	X
Shutdown stand-by controller		X	X	X
Reset stand-by controller		X	X	X
DS2 #1-7 mode (T1 or E1)		X	X	X
<b>Configuration – T1/E1 Interface Menu</b>				
T1/E1 state		X	X	X
T1/E1 line coding		X	X	X
T1/E1 line length		X	X	X
T1/E1 loopback detection		X	X	X
T1/E1 circuit protection		X	X	X
T1/E1 protection threshold		X	X	X
T1/E1 line identification		X	X	X

**Table 3-4. Console Menu User Privileges (Continued)**

Console Menu Item	Privilege level(s) under which a user may alter (and in some cases, view) this item			
	Guest	Interface	Test	Admin
T1/E1 XCV threshold		X	X	X
<b>Configuration – System Management Menu</b>				
Local IP address				X
Gateway IP address				X
Subnet mask				X
Modem remote IP address (controller with modem)				X
Management port				X
Forward IP to remote DS3				X
DS3 remote IP address				X
Dial-up Option menu (controller with modem)				X
DS3 IP MTU				X
System Name				X
SNMP Management Option menu				X
Network Date/Time Option menu				X
User Account Management menu				X
Terminal time out				X
IP security				X
IP hosts				X
Date				X
Time				X
Alarm Relay Configuration menu				X
Equipment ID menu				X
Syslog Setup menu				X
Save-on-logout		X	X	X
Craft baud rate		X	X	X
<b>Telnet Client menu</b>				
IP Address				X

Table 3-4. Console Menu User Privileges (Continued)

Console Menu Item	Privilege level(s) under which a user may alter (and in some cases, view) this item			
	Guest	Interface	Test	Admin
TCP Port				X
Connect				X
<b>Configuration – Utilities Menu</b>				
Load default settings				X
Update flash software				X
Configuration transfer				X
System reset				X
<b>Configuration – Protection Switching Menu</b>				
Active controller		X	X	X
Max switch threshold		X	X	X
Min switching period		X	X	X
<b>Loopback Menu</b>				
T1/E1 loopbacks			X	X
DS2 loopbacks			X	X
DS3 loopbacks			X	X
Reset all tests			X	X
Clear BERR			X	X
Save Configuration & Alarm Log	X	X	X	X
Logout	X	X	X	X

“X” denotes a privilege level that allows execution of the associated menu item.



## Terminal Time Out

Set the amount of time the terminal or Telnet session remains inactive before automatically closing the session, requiring the user to log in again. Options include the following:

- Disabled
- 1 min.
- 5 min.
- 15 min.
- 60 min.
- 1 day.

## IP Security

Enable or disable the IP Security option. If IP Security is set to Enabled, the unit accepts management commands and Telnet sessions from the IP addresses entered into the IP Hosts fields.

## IP Hosts

Enter up to 16 IP addresses of management stations from which the unit should accept management commands. These addresses are applicable only if IP Security is Enabled.

## Date and Time

Enter date and time information. Enter the month, date, and year separated by forward slashes (02/23/04). Enter the time in military time separated by colons (13:15:25).

## Miscellaneous

The Miscellaneous option of the System management menu sets the fields and values for the

- Alarm Relay Configuration
- Equipment Identification
- Syslog Setup
- Auto Save
- Craft baud rate

## Alarm Relay Configuration

This menu enables and disables audible and visible alarms for specific error conditions. See [Figure 3-15](#).

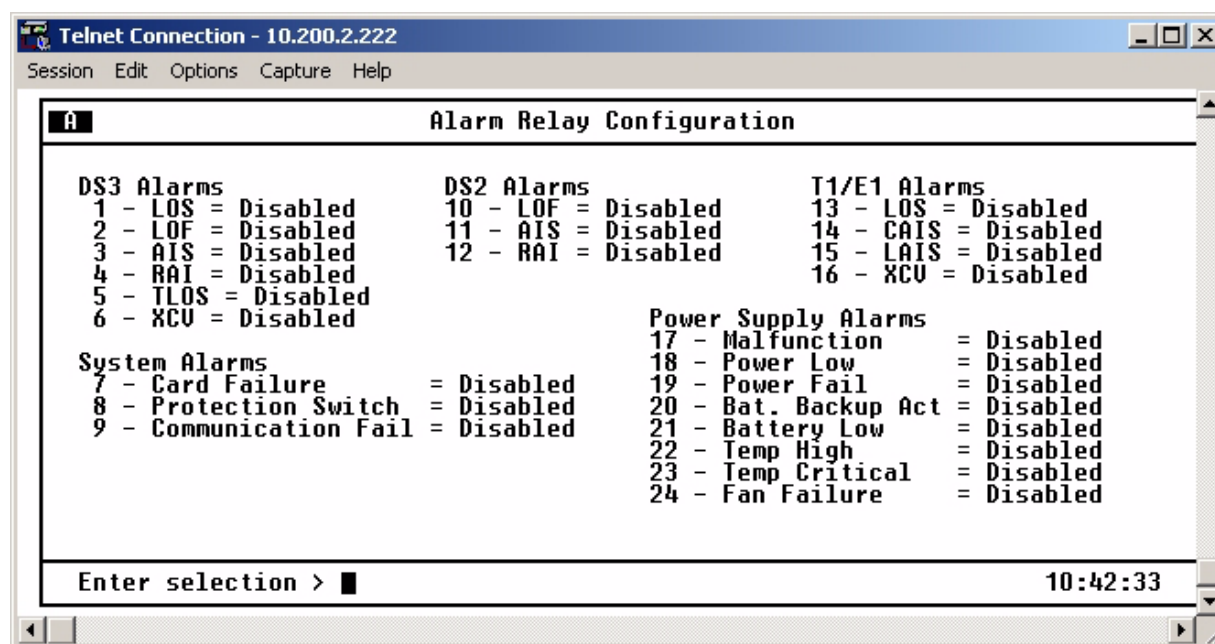

Figure 3-15. Alarm Relay Configuration Menu

Table 3-5 describes the alarm conditions found in the Alarm Relay Configuration menu.

Table 3-5. Types of Alarms in Alarm Relay Configuration

Alarm	Level	Description
<b>DS3 Alarms</b>		
RAI	Critical	The unit is receiving an RAI (yellow) alarm from the network. This alarm is a signal sent back toward the source of a failed transmit circuit. The X-bits (X1 and X2) are set to zero.
AIS	Critical	The unit is receiving an AIS (blue) alarm from the network. This alarm occurs when consecutive 1010s are received in the information bits, indicating the fault lies at or upstream from the transmitting source.
LOS	Critical	The unit has lost the network Rx signal.
LOF	Critical	The unit detects a framing loss from the network.
XCV	Noncritical	The controller card is receiving code violations in excess of the user specified threshold. Refer to <i>XCV Threshold</i> on page 3-15.
TLOS	Critical	The controller card transmitter has failed.
<b>DS2 Alarms</b>		
RAI	Noncritical	The unit is receiving an RAI (yellow) alarm from the network across a DS2. This alarm is a signal sent back toward the source of a failed transmit circuit. The X-bits (X1 and X2) are set to zero.
AIS	Noncritical	The unit is receiving unframed all ones across a DS2.

**Table 3-5. Types of Alarms in Alarm Relay Configuration (Continued)**

Alarm	Level	Description
LOF	Noncritical	The unit detects a framing loss from the network across a DS2.
<b>System Alarms</b>		
Controller Card A/B Fail	Critical	Controller Card A/B has failed. <sup>1</sup>
Protection Switch	Critical	The unit detects a Controller Card protection switch. Data is routed from the primary to stand-by card.
Communication Fail	Noncritical	The Controller Cards can no longer communicate.
<b>T1/E1 Alarms<sup>2</sup></b>		
LOS	Noncritical	The unit has lost the receive signal on a T1/E1.
XCV	Noncritical	The controller card is receiving code violations in excess of the user specified threshold. Refer to <i>XCV Threshold</i> on page 3-15
Carrier Side AIS (CAIS)	Noncritical	The T1 is receiving all ones from the DS3 side of the network.
Loop Side AIS (LAIS)	Noncritical	The T1 is receiving all ones from the DSX-1 interface.
<b>Power Supply Alarms</b>		
Malfunction	Noncritical	Power supply card is no longer working. The unit has switched to the backup power supply or battery backup.
Power Low	Noncritical	Power supply's output level is abnormally low.
Power Fail	Noncritical	Power supply card does not detect power input.
Bat. Backup Act	Noncritical	Battery charger has lost its AC power source.
Battery Low	Noncritical	Battery backup has reached an energy point insufficient to supply the unit with power.
Temperature High	Noncritical	Power supply card temperature is above normal.
Temperature Critical	Noncritical	Power supply card temperature is so high that it may suffer damage.

1. This is a critical alarm only when Inactive Card is not installed or is not working.
2. T1/E1 alarms are cleared when the T1/E1 is disabled or set to Auto Enable after receiving an alarm.

## Equipment Identification

These fields are used to store information that identifies the unit. See [Figure 3-16](#) on page 3-36. Information provided for the far-end is read-only. Local information is read/write from this menu.

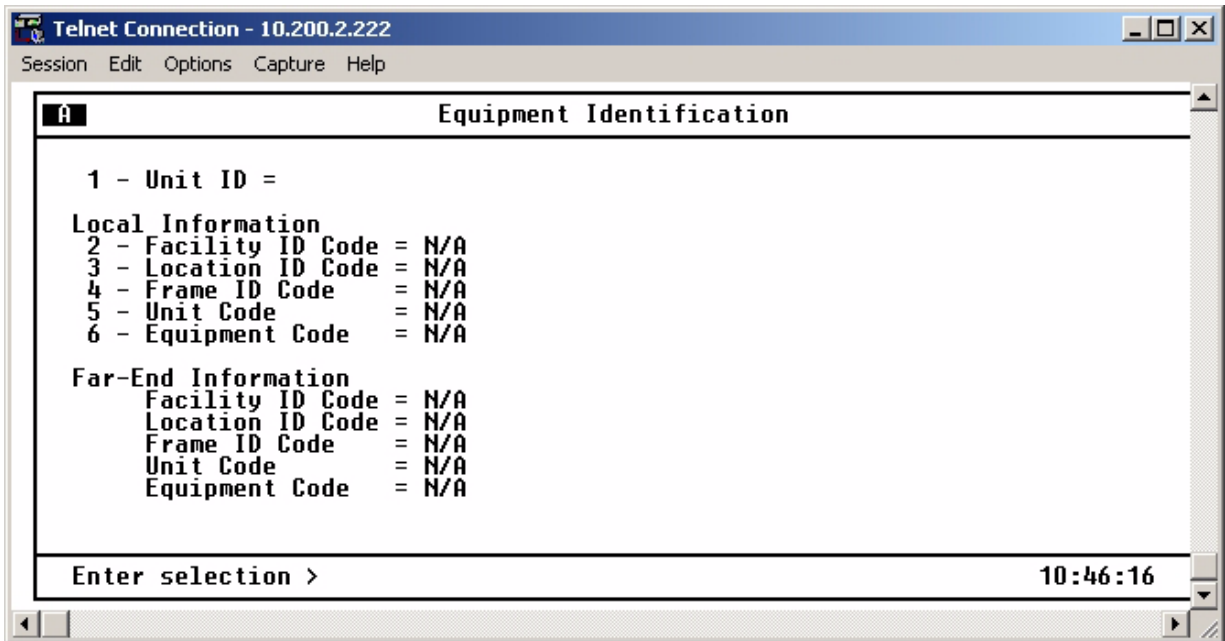

Figure 3-16. Equipment Identification Menu

### Unit ID

This option provides a user-configurable text string for the name of the MX2800. This name can help distinguish between different installations. Up to 32 alphanumeric characters can be entered in this field. This information is locally stored and displayed in the upper right-hand corner of the MX2800 terminal screens. This identifier is used as the system's TID for TL1.

### Facility ID

The Facility ID Code supports 38 alphanumeric characters and provides user-configurable text strings to identify the MX2800 over the network. This information is transmitted over the DS3 on the equipment ID channel.

### Location ID

The Location ID Code supports 10 alphanumeric characters and provides user-configurable text strings to identify the MX2800 over the network.

### Frame ID

The Frame ID Code supports 10 alphanumeric characters and provides user-configurable text strings to identify the MX2800 over the network.

### Unit Code

The Unit Code supports 6 alphanumeric characters and provides user-configurable text strings to identify the MX2800 over the network.

## Equipment Codes

The Equipment Code supports 10 alpha-numeric characters and provides user-configurable text strings to identify the MX2800 over the network.

## Syslog Setup

These selections include Transmission, Host IP Address, Severity Level, and Host Facility.

### Transmission

This option enables or disables the transmission of log events to the external Syslog server. The host IP address must be defined first.

### Host IP Address

This option specifies the IP address of the external server that is running the Syslog host daemon.

### Severity Level

This option specifies the lowest level of severity that causes messages to be logged to the Syslog server. The levels are listed in [Table 3-6](#) in order of decreasing severity. Any message at or above a selected severity level will be logged if a transmission is enabled.

**Table 3-6. Syslog Severity Levels**

Level	Description
Emergency	The system is unusable.
Alert	An action must be taken immediately.
Critical	Shows critical conditions.
Error	Shows error conditions.
Warning	Shows warning conditions.
Notice	Shows normal but significant conditions.
Info	Shows informational messages.
Debug	Shows a debug-level message.

### Host Facility

This option specifies the facility destination of log events. Facilities are located on the host and are managed by the Syslog host daemon running on either a UNIX machine or a PC. Options include Local 0-7.

## Auto Save

Enable this function to save the configuration every five minutes and upon logout. Disable this option if the configuration is not to be saved. The configuration may be saved manually from the Configuration menu.

## Craft Baud Rate

This value sets the rate at AUTO, 9600, 19200, 38400, and 57600 baud rate.

## 5. UTILITIES

The System Utilities menu, see [Figure 3-17](#), is used to view MX2800 system information for both controller cards:

- Self-test results
- Revert to default configuration settings
- Flash-load a new version of software
- Transfer configuration information to and from a Trivial File Transfer Protocol (TFTP) server
- Reset the system

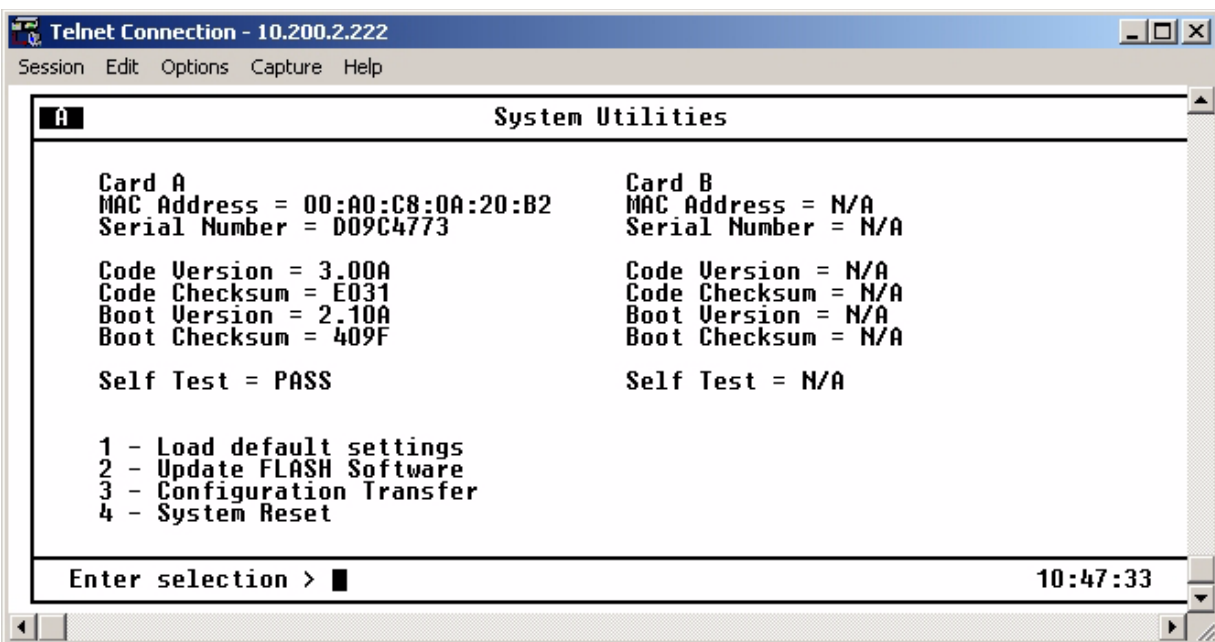

Figure 3-17. System Utilities Menu

Possible results for the self-test are listed in [Table 3-7](#) on page 3-39.

**Table 3-7. Self-Test Results**

<b>If the self test results are...</b>	<b>Then...</b>
PASS	The self-test was successful and the unit is ready to use.
BAD RAM DATA BAD RAM ADDRESS BAD CODE CHECKSUM BAD BOOT SECTOR IOX PROGRAM FAILURE AFE PROGRAM FAILURE MODEM FAILURE ETHERNET FAILURE DS3 FAILURE DSX FAILURE	Contact ADTRAN Technical Support. For more information, refer to <a href="#">Appendix F, Warranty</a> .
CONFIGURATION CORRUPT	Select Save Configuration from the Configuration menu. If the condition persists, contact ADTRAN Technical Support.

## Loading Default Settings

Select Load Default Settings from the Utilities menu. Three options are available for loading default settings.

### Load Default Settings Other Than System Management

This option defaults all Network and T1/E1 interfaces but does not change management-related options. Refer to [Management Options](#) on page 3-17 for the management-related options.

---

#### CAUTION

Loading the default settings will set the T1/E1 state of all DS1 ports to Auto Enable.

---

### Load System Management Default Settings

This option defaults all management-related settings but does not default settings for Network and T1/E1 interfaces.

---

#### CAUTION

Loading the default settings will set the T1/E1 state of all DS1 ports to Auto Enable. The User Account Management table is also reset to default.

---

## Load All Default Settings

This option defaults all settings for the unit. Once the settings have been successfully retrieved, Command Accepted will appear at the bottom of the screen

---

### CAUTION

The User Account Management table is also reset to default.

---

## Updating Software

Select Update Flash Software from the Utilities menu to update software, using either XModem protocol or TFTP.

---

### NOTE

Before beginning update of Flash software, disable the Auto Save feature of the MX2800. From the Configuration menu, choose System Management, then select Auto Save and toggle until it is set to Disable.

---

## Update Via XModem

Updating the Flash Software via XModem requires that a VT100 terminal menu session be active through the units craft port. To update the software via XModem, follow these steps:

1. From the MX2800 Main Menu, select Configuration, then Utilities, then Update Flash Software, and then Update via XModem.
2. Once it has been determined where the new binary file is located, select Start to begin the transfer.
3. Once Start has been selected, start the XModem transfer from the terminal menu program that is being used by selecting or typing the file path for the location of the new binary file. Refer to the appropriate documentation for the terminal emulator to begin XModem transfer.
4. After the binary file has been selected, the XModem transfer will begin. To cancel a transfer in progress, press CTRL+X three times. The **ACT** LED on the active card is solid amber for the duration of XModem transfer. The **ACT** LED on the standby card is flashing green.
5. If updating a unit with redundant controller cards, the active controller will begin uploading the new code to the standby controller after the XModem transfer has completed and the unit has successfully loaded and programmed the new software into its Flash memory. If the unit does not have redundant controller cards, go to [Step 7](#).
6. While the standby card is having code uploaded, the **ACT** LED on the standby card will be solid amber. After the code has finished uploading to the standby card, the card will reset itself and begin running the new code.



---

**CAUTION**

The standby card must remain in place until the upload process is complete and the **ACT** LED is no longer solid amber and returns to flashing green. Removing the standby card during the uploading process will corrupt the software.

---

7. The system must be manually reset after downloading new software for the active controller card to begin running the new code. From the Utilities menu, select System Reset, then select either Immediate Reset to immediately reset the system or Schedule Reset Time to set a time for the system to reset. Once the system has been reset, the new software will be running.

---

**NOTE**

This function is available only when updating the software through the craft port.

---

## Update Via TFTP Server

Updating the FLASH Software via TFTP Server requires that the IP address and file name of file to be downloaded be known. To update the software via TFTP, follow the steps below:

1. Select Update via TFTP Server from the Utilities menu. A new menu displays, allowing the IP address and file name of the file to be downloaded to the unit to be entered. Once this information is entered, select Start/Stop Transfer.
2. After the binary file is selected, the TFTP transfer will begin. To cancel a transfer in progress, press CTRL+X three times. The **ACT** LED on the active card is solid amber for the duration of TFTP transfer. The **ACT** LED on the standby card is blinking green.
3. If updating a unit with redundant controller cards, the active controller begins uploading the new code to the standby controller after the XModem transfer has completed; and the unit has successfully loaded and programmed the new software into its FLASH memory. If the unit does not have redundant controller cards, go to [Step 5](#).
4. While the standby card is having code uploaded, the **ACT** LED on the standby card will be solid amber. After the code has finished uploading to the standby card, the card will reset itself and begin running the new code.

---

**CAUTION**

The standby card must remain in place until the upload process is complete, and the **ACT** LED is no longer solid amber. Removing the standby card during the uploading process will corrupt the software.

---

5. The system must be manually reset after downloading new software for the active controller card to begin running the new code. From the Utilities menu, select System Reset. Then select either

---

Immediate Reset to immediately reset the system or Schedule Reset Time to set a time for the system to reset. Once the system has been reset, the new software will be running.

---

**NOTE**

After new software has been downloaded to the MX2800 system, a condition known as a “software version mismatch” exists on the active card. The currently running software version is different from the version of the new software that was just programmed into the card's nonvolatile memory. This condition occurs because a manual card reset is necessary for the card to begin running the new software. If the software version being run by the system before the upgrade began was 2.00 or higher, this mismatch will be indicated by a TL1 standing condition (condition code PROGFLT) and a repeating message displayed at the bottom of all menu screens. This is not a service-affecting condition; however, it is recommended that the download process be completed by resetting the active card as soon as it is practical. Doing so assures that all improvements in the new software are fully available.

---

## Configuration Transfer

Select Config Transfer from the Utilities menu to transfer files to and from a TFTP server. The Config Transfer option is used to save the MX2800 configuration as a backup file, ensuring that the same configuration can be used with multiple MX2800 units. Only one configuration transfer session (upload or download) can be active at a time.

---

**NOTE**

Before using Config Transfer, the MX2800 should have a valid IP address, subnet mask, and default gateway (if required) and should be connected to an Ethernet network.

---

## Saving to a TFTP Server

To save current configuration information to a TFTP server, follow the steps listed below:

1. Set the **Server IP Address** field to the IP address of the machine running the TFTP server program.  
If the ADTRAN TFTP server is being used, the IP address displays in the Server IP Address field. For other TFTP servers, refer to the appropriate documentation.
2. Change the **TFTP Server Filename** to a unique filename. This will be the name of the configuration file saved to the remote server.

---

**NOTE**

Some TFTP servers constrain the format of the filename, depending on the operating system of the server. For example, a TFTP server running on a PC under Windows 3.1 may permit only 8.3 format filenames (8 characters, period, and three extension characters).

---

3. Select Save Config Remotely.

## Retrieving from a TFTP Server

To retrieve current configuration information from a TFTP server, follow the steps listed below:

1. Set the Server IP Address field to the IP address of the machine running the TFTP server program.  
If the ADTRAN TFTP server is being used, the IP address displays in the Server IP Address field. For other TFTP servers, please refer to the appropriate documentation.
2. Change the TFTP Server File Name to a unique filename, including the complete path. This will be the name of the configuration file retrieved from the remote server.

---

**CAUTION**

Configuration changes will not be implemented until all Telnet sessions are closed. Loading a new configuration may disrupt data traffic.

---

3. Select Load and Use Config.

---

**NOTE**

IP address and management port settings remain unchanged when a configurative is retrieved from a TFTP server.

---

## Resetting the System

The system must be manually reset after downloading new software. When the unit has successfully loaded and programmed the new software into its FLASH memory, it will begin uploading the code to the standby controller. This will be indicated on the menu and the **ACT** LED on the standby card will display solid yellow.

---

**CAUTION**

The standby card must remain in place until the process is complete and the **ACT** LED is no longer solid yellow. Removing the standby card during the uploading process will corrupt the software.

---

Once the upload is complete, the standby card will self-reset and begin running the new code. However, the active card does not reset automatically. The unit must be reset through the Immediate Reset or Schedule Reset Time functions.

## 6. SAVE CONFIGURATION AND ALARM LOG

Commits the current configuration and alarm log to nonvolatile memory. If this option is not selected after making changes to the configuration, the unit reverts to its previous configuration when powered down. When the selection is made, a response is displayed on the Save Configuration and Alarm menu. See [Figure 3-18](#) on page 3-44.

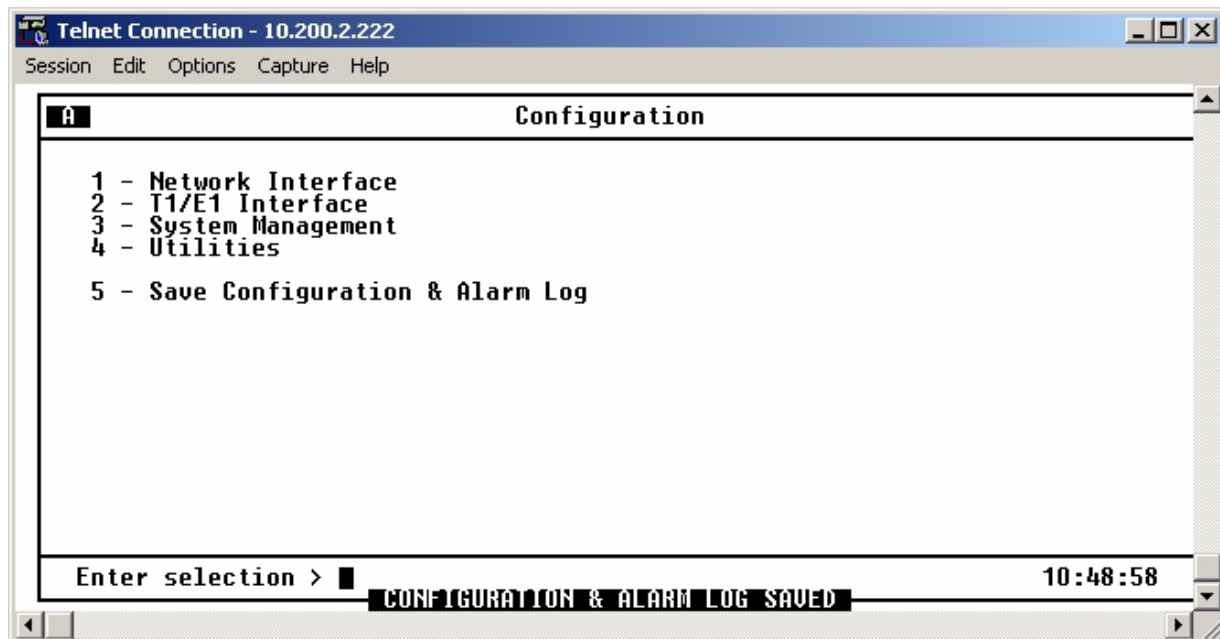
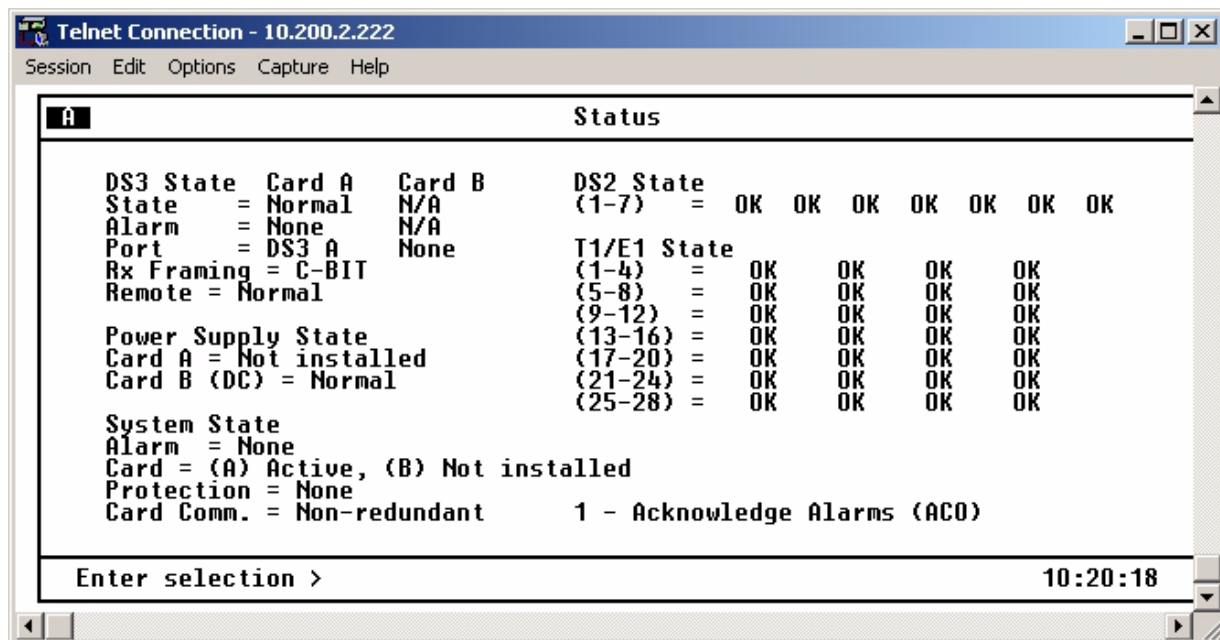

Figure 3-18. Indication of a Saved Configuration and Alarm Log

## Section 4 Status

### 1. INTRODUCTION

View MX2800 status information by selecting Status from the Main Menu. The information for the DS3, DS2s, T1/E1 lines, power supplies, and controller cards is provided. See [Figure 4-1](#).



```
Telnet Connection - 10.200.2.222
Session Edit Options Capture Help

A Status

DS3 State Card A Card B DS2 State
State = Normal N/A (1-7) = OK OK OK OK OK OK OK
Alarm = None N/A
Port = DS3 A None
Rx Framing = C-BIT
Remote = Normal

Power Supply State
Card A = Not installed
Card B (DC) = Normal

T1/E1 State
(1-4) = OK OK OK OK
(5-8) = OK OK OK OK
(9-12) = OK OK OK OK
(13-16) = OK OK OK OK
(17-20) = OK OK OK OK
(21-24) = OK OK OK OK
(25-28) = OK OK OK OK

System State
Alarm = None
Card = (A) Active, (B) Not installed
Protection = None
Card Comm. = Non-redundant 1 - Acknowledge Alarms (ACD)

Enter selection > 10:20:18
```

Figure 4-1. Status Menu

### 2. DS3 STATE

This field displays the current state of the DS3. The following subsections describe the DS3 status fields in detail.

#### Rx Framing

This field shows the network framing type (C-Bit or M13).

## State

This field displays the current condition of the network. Possible conditions are listed in [Table 4-1](#).

**Table 4-1. Network State Conditions**

Condition	Description
Normal	The MX2800 is ready to pass data.
Alarm	The unit is currently receiving an alarm indication. For alarm types, refer to the <a href="#">Alarm</a> subsection.
In Test	The unit is currently in test mode. Refer to <a href="#">Section 6, Loopbacks</a> for information on the test type.

## Alarm

This field displays the current alarm condition of the MX2800. Possible conditions are given in [Table 4-2](#).

**Table 4-2. Alarm Conditions**

Condition	Description
Normal	No alarms are currently being received.
RAI	The unit is receiving an RAI (yellow) alarm from the network. This alarm is a signal sent back toward the source of a failed transmit circuit. The X-bits (X1 and X2) are set to zero.
LOS	The unit has lost the Rx signal.
AIS	The unit is receiving an AIS (blue) alarm condition from the network. AIS alarms occur when consecutive 1010s are received in the information bits, indicating that there is a transmission fault located either at or upstream from the transmitting terminal.
LOF	The unit detects a framing loss from the network.
XCV	The unit is receiving excessive code violations from the network, exceeding the threshold set by the user. For more information, refer to <a href="#">XCV Threshold</a> on page 3-15.
TLOS	The transmitter has failed.
Idle	The unit detects an idle sequence from the network.

## Remote

This field indicates the current state of the remote MX2800 (available with C-Bit framing only). Possible conditions are given in [Table 4-3](#).

**Table 4-3. Remote Alarm Conditions**

Condition	Description
Normal	The far-end MX2800 is not reporting any alarm conditions.
RAI	The far-end unit is receiving an RAI (yellow) alarm from the network. This alarm is a signal sent back toward the source of a failed transmit circuit. The X-bits (X1 and X2) are set to zero.
LOS	The far-end unit has lost the Rx signal.
AIS	The far-end unit is receiving an AIS (blue) alarm condition from the network. AIS alarms occur when consecutive 1010s are received in the information bits, indicating that there is a transmission fault located either at or upstream from the transmitting terminal.
LOF	The far-end unit detects a framing loss from the network.
Idle	The far-end unit detects an idle sequence from the network.
DS3 Eqpt Fail (SA)	The far-end unit or network is reporting a service-affecting DS3 equipment failure.
DS3 Eqpt Fail (NSA)	The far-end unit or network is reporting a non-service-affecting DS3 equipment failure.
Common Eqpt Fail (NSA)	The far-end unit or network is reporting a non-service-affecting common equipment failure.
Multiple DS1 LOS	The far-end unit is experiencing a loss of signal on multiple DS1s.
Single DS1 LOS	The far-end unit is experiencing a loss of signal on a single DS1.
DS1 Eqpt Fail (SA)	The far-end unit is experiencing a service-affecting DS1 equipment failure.
DS1 Eqpt Fail (NSA)	The far-end unit is experiencing a non-service-affecting DS1 equipment failure.
Unknown	The unit is unable to discern the status of the far-end unit. (Normal for M13 framing.)

### 3. POWER SUPPLY STATE

This field indicates which types of power supplies are installed (AC or DC) in Card A and Card B and gives their current state. See [Table 4-4](#).

**Table 4-4. Power Supply Conditions**

Condition	Description
Normal	The power supply is fully operational.
Error	The controller card cannot communicate with the power supply.
Power Low	The power supply output level is abnormally low.
Power Fail	The power supply input power is lost.
Charger Fail	The battery backup charger has failed or has lost its AC input.
Battery Low	The battery backup has reached an insufficient energy level to power the unit.
Temp High	The power supply card temperature is abnormally high.
Temp Critical	The power supply card temperature is so high that it is approaching shut off.

### 4. SYSTEM STATE

These fields display information regarding the two controller cards. The following sections describe the system state fields in detail.

#### Alarm

This field displays what type (if any) of system alarm is currently recognized by the unit. The condition is displayed until it clears up, with the exception of the Switched condition (which is cleared manually) and the Excessive Switches (which is cleared when Protection Switch alarms counts are cleared). For more information, refer to [Protection Switch Statistics](#) on page 5-14.

To clear the Switched condition, select Acknowledge Alarms (ACO) or push the **ACO** button on the front panel. For more information, refer to [ACO Buttons](#) on page 2-15 and [Acknowledge Alarms \(ACO\)](#) on page 4-6 in this section. Possible alarm types are listed in [Table 4-5](#).

**Table 4-5. System State Alarm Types**

Condition	Description
Supply Failure	A power supply card has failed.
Card Failure	A controller card is not passing data.
Excessive Switches	The Max Switching Threshold has been exceeded. Refer to <a href="#">Maximum Switch Threshold</a> on page 3-6.
Switched	A card switch has occurred.



## Card A/Card B

These fields display the current state of the two controller cards. Possible states for the controller cards are listed in [Table 4-6](#).

**Table 4-6. Controller Card States**

Condition	Description
Not Installed	No controller card is installed in this slot.
Standby	The controller card is ready to pass data but is currently acting as a backup card.
Active	The controller card is acting as the primary card.
Failure	The controller card has failed and needs to be replaced.

## Protection

This field lists the type of protection mode currently active. Possible states are listed in [Table 4-7](#).

**Table 4-7. Protection Types**

Condition	Description
Network	Both controller cards are installed and everything is healthy. The unit is in full network protection mode.
Circuit	Unit is in Circuit Protection Mode and everything is healthy, or unit is in network protection mode and a failure is present on the network.
None	One controller card is installed, or the unit is in Circuit Protection Mode, and the secondary card has failed.

---

### NOTE

For more information on the various types of Protection Modes, refer to [Section 7, Circuit and Network Redundancy](#).

---

## Card Comm

This field displays the current state of the communication link between the two controller cards.

- OK indicates that the cards are communicating
- Failure indicates that the cards are not able to communicate with each other
- If there is only one card installed, Non-Redundant is displayed

## 5. DS2 STATE

This field displays the current state of each of the seven DS2s. Possible states are listed in [Table 4-8](#).

**Table 4-8. DS2 States**

Condition	Description
OK	The DS2 is not receiving alarms.
LOF	The unit detects framing loss across the DS2.
RAI	The unit is receiving an RAI (yellow) alarm across the DS2. This alarm is a signal sent back toward the source of a failed transmit circuit. The X-bit is set to zero.
AIS	The unit is receiving an AIS (blue) alarm condition from the network across the DS2. AIS alarms occur when the unit receives unframed all ones.

## 6. T1/E1 STATE

This field displays the current state of the individual T1s or E1s. Possible states are listed in [Table 4-9](#).

**Table 4-9. T1/E1 States**

Condition	Description
OK	The T1/E1 is ready to pass data.
LOS	The unit has lost the Rx signal on the T1/E1.
XCV	The unit is receiving excessive code violations across the T1/E1, exceeding the configured threshold (refer to <a href="#">XCV Threshold</a> on page 3-15).
TST	The T1/E1 is currently in test mode.
HOT	The T1/E1 transceiver temperature is too high.
LAIS	The T1 is receiving all ones from the DSX-1 interface.
CAIS	The T1 is receiving all ones from the DS3 side of the network.

---

### NOTE

A DS2 can be divided into either three E1s or four T1s. Therefore, when dealing with an E1 configuration, some of the fields in the T1/E1 State menus do not apply (and display nothing).

---

## 7. ACKNOWLEDGE ALARMS (ACO)

This selection is used to remotely turn off an active alarm. It is the software equivalent of the **ACO** button as described in [ACO Buttons](#) on page 2-15.

## Section 5 Statistics

### 1. INTRODUCTION

To access Statistics menu, select Statistics from the Main Menu. See [Figure 5-1](#). Alarm information and performance parameters are available for both the near and far ends of the network. Information is also given for the individual DS2s and T1/E1 lines.

### 2. VIEWING STATISTICAL INFORMATION

Statistical information is given in screens based on these time periods:

- The current 15-minute interval
- A 24-hour history (divided into 96 15-minute intervals)
- The totals for the previous 24 hours
- A cumulative alarm count is given (this count continues indefinitely until reset by the user)

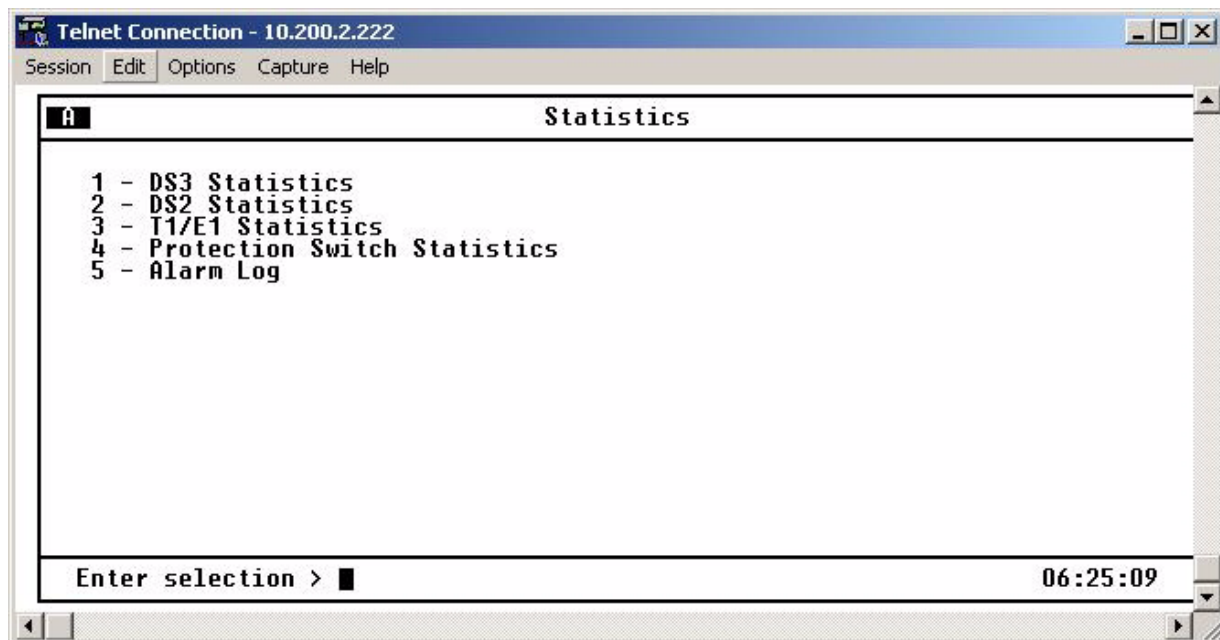
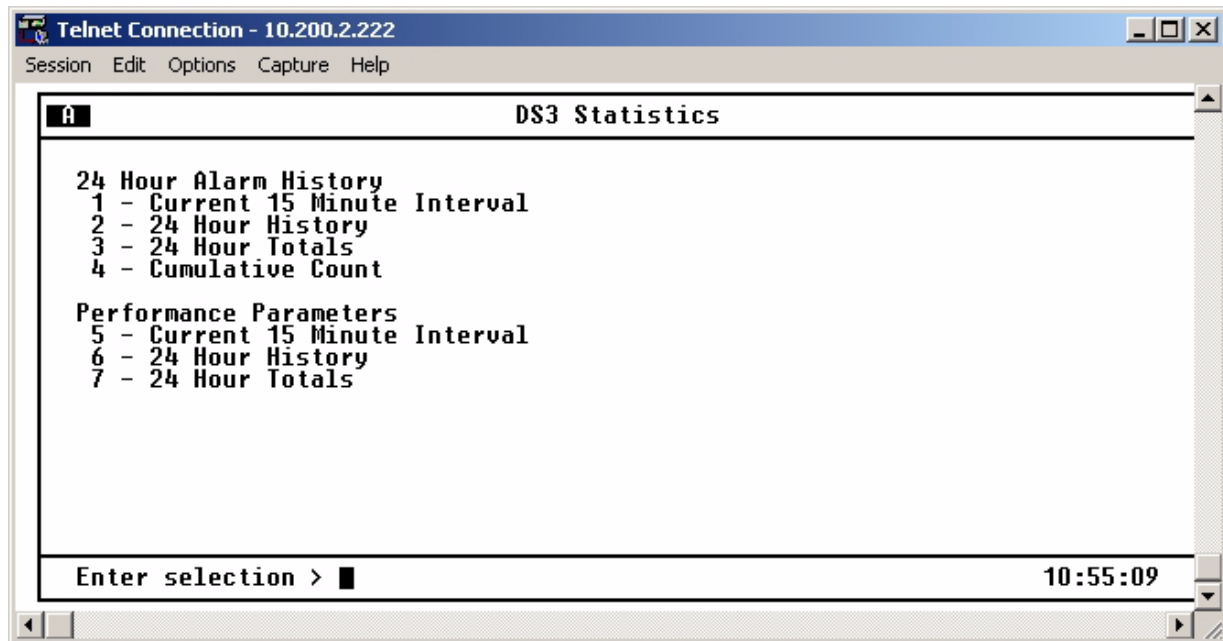

Figure 5-1. Statistics Menu

## DS3 Statistics

The DS3 Statistics menu, see [Figure 5-2](#), provides submenus for alarm history and performance parameters.



**Figure 5-2. DS3 Statistics Menu**

### 24 Hour Alarm History

The MX2800 keeps track of alarms for both the near and far ends of the network. View alarm history information in one of the three time period selections, or view a cumulative alarm count. Information in these fields is for the given time period since the last reset. The cumulative alarm count continues indefinitely until Clear All DS3 Alarm Counts is selected. See [Table 5-1](#) for a list of alarm counts. See [Figure 5-3](#) on page 5-3 and [Figure 5-4](#) on page 5-4 for examples of alarm screens.

**Table 5-1. Alarm Counts**

Condition	Description
LOS	Number of times the unit has lost the receive signal.
LOF	Number of times the unit has detected a loss of framing from the network.
AIS	Number of times the unit has received an AIS (blue) alarm condition from the network. AIS alarms occur when consecutive 1010s are received in the information bits. This indicates that there is a transmission fault located either at or upstream from the transmitting terminal.
RAI	Number of times the unit has received an RAI (yellow) alarm from the network. This alarm is a signal sent back toward the source of a failed transmit circuit. The X-bits (X1 and X2) are set to zero.

**Table 5-1. Alarm Counts (Continued)**

Condition	Description
IDLE	Number of times the unit has detected an idle sequence from the network.

**NOTE**

The count given reflects the number of times the alarm or state has occurred rather than the number of seconds the alarm was active.

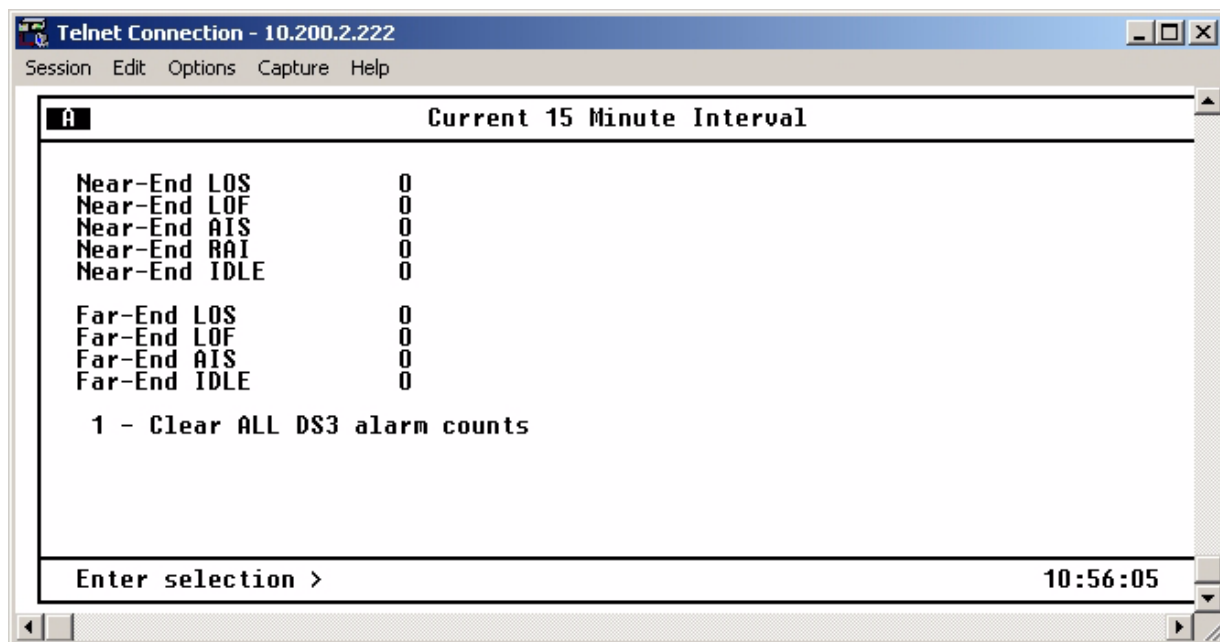
**Figure 5-3. DS3 Current 15 Minute Alarm Count Screen**

Interval starting	10:30	10:15	10:00	09:45	09:30	09:15
Near-End LOS	0	0	0	0	0	0
Near-End LOF	0	0	0	0	0	0
Near-End AIS	0	0	0	0	0	0
Near-End RAI	0	0	0	0	0	0
Near-End IDLE	0	0	0	0	0	0
Far-End LOS	0	0	0	0	0	0
Far-End LOF	0	0	0	0	0	0
Far-End AIS	0	0	0	0	0	0
Far-End IDLE	0	0	0	0	0	0

1 - Clear ALL DS3 alarm counts

Enter selection >

10:56:44

Figure 5-4. DS3 24-Hour Alarm History Screen

#### NOTE

When a > or < symbol appears in the upper corner of the screen, use the right and left arrow keys on the keyboard to scroll right or left to view additional information. See the upper right-hand corner of [Figure 5-4](#).

### Performance Parameters

View performance parameter information for the network in one of the three time period selections. Information in these fields is for the given time period since the last reset. When viewing the 24-hour history statistics screen, use the left and right arrow keys to scroll through all 96 15-minute intervals. See [Figure 5-5](#) on page 5-5, [Figure 5-6](#) on page 5-6, and [Figure 5-7](#) on page 5-7 for examples of the performance parameter screens.

Descriptions of the fields in each screen follow.

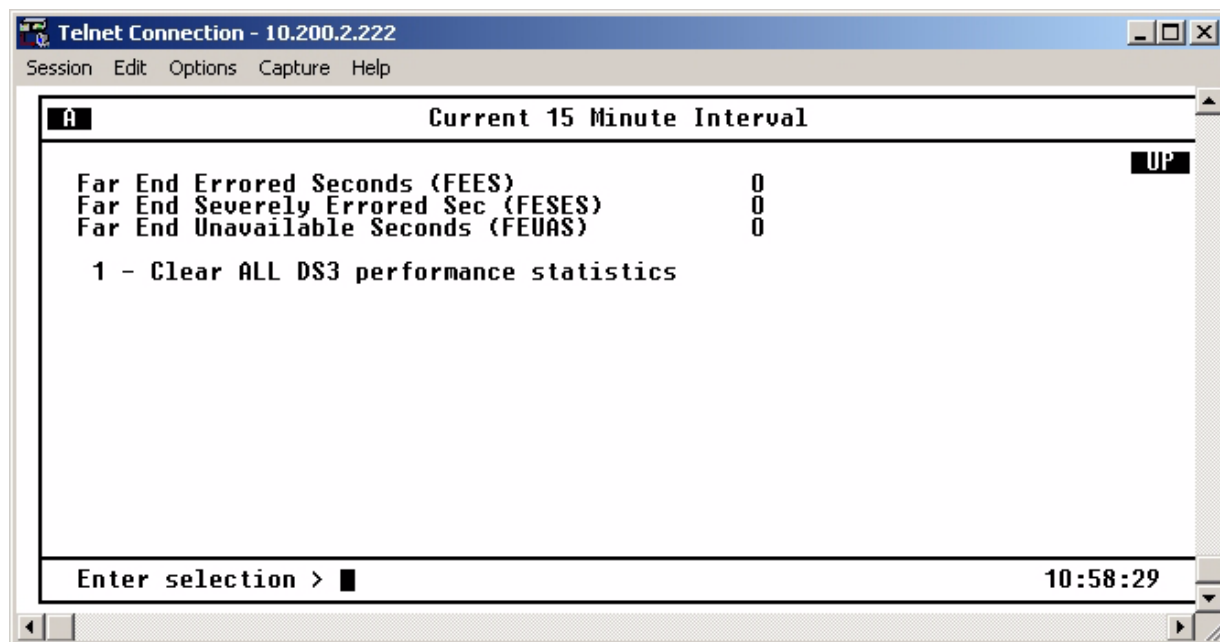
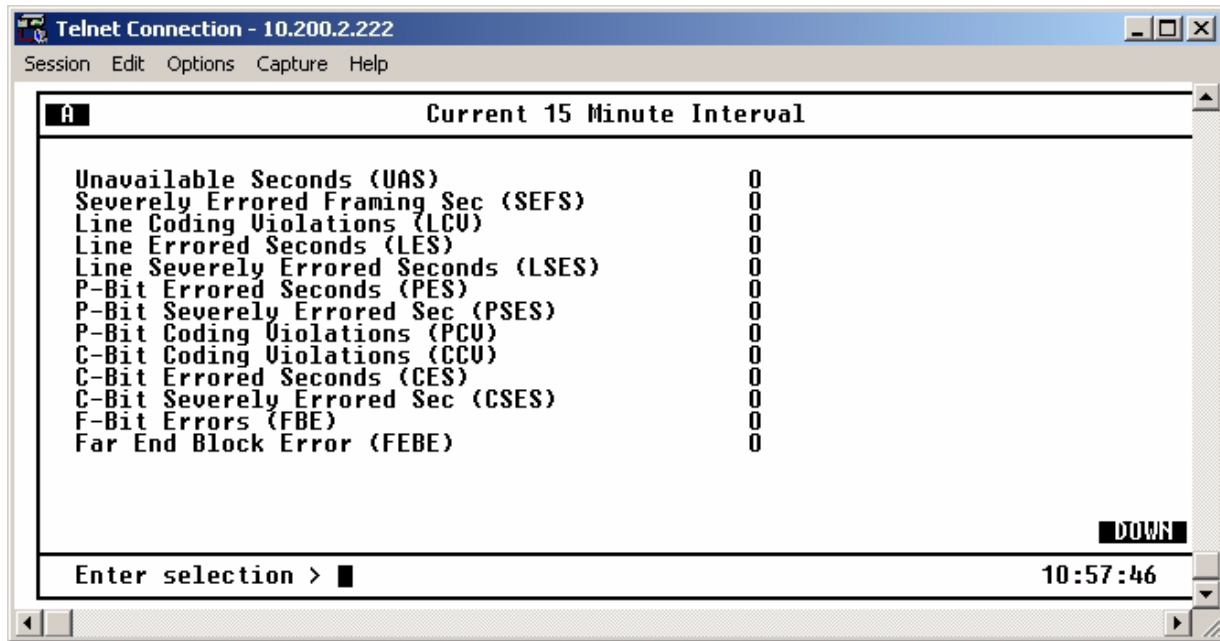

Figure 5-5. DS3 Performance Parameters (Current 15 Minutes)

---

**NOTE**

When an UP or DOWN indicator appears in the corner of the screen, use the up and down arrow keys on the keyboard to scroll the information.

---

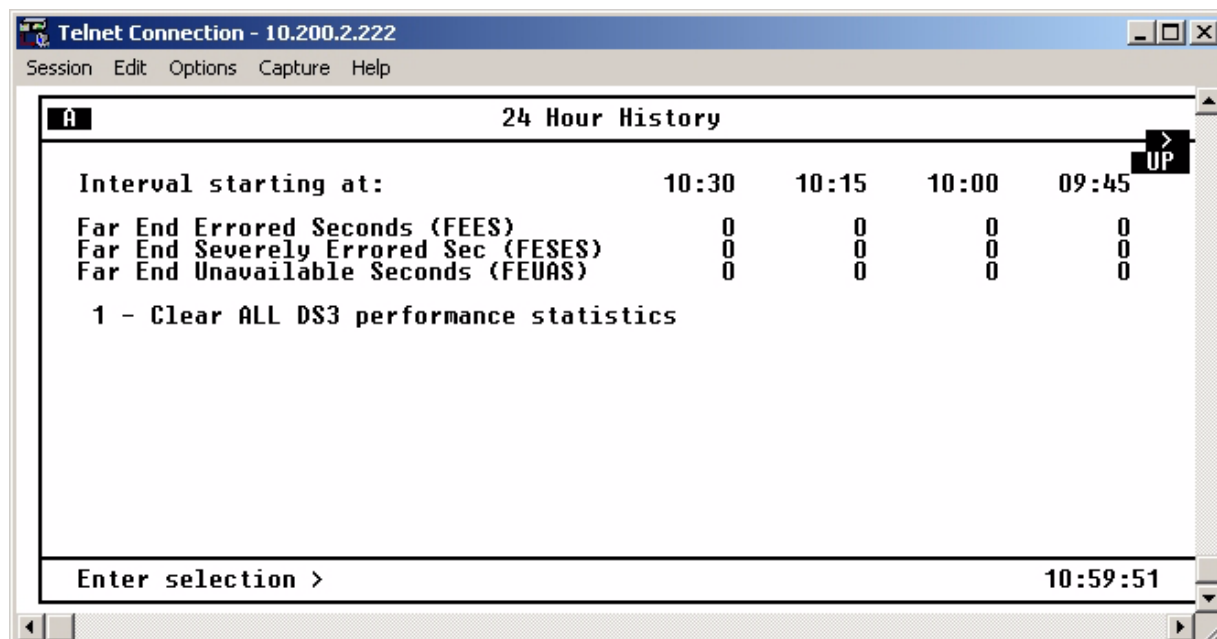
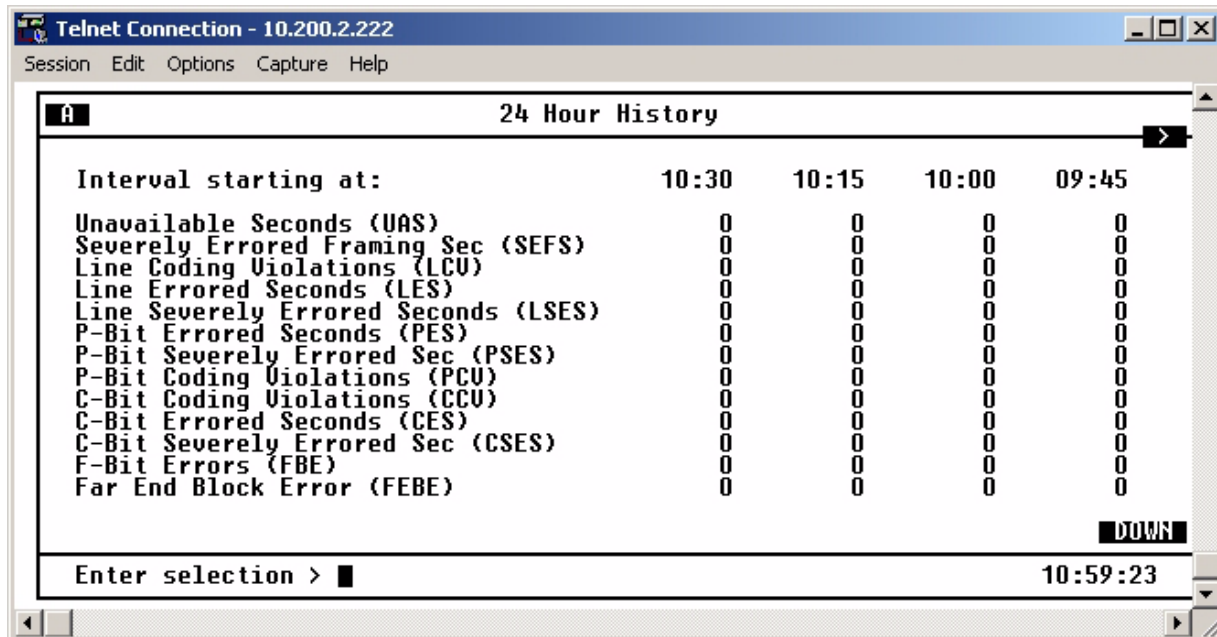

Figure 5-6. DS3 Performance Parameters (24 Hour History)



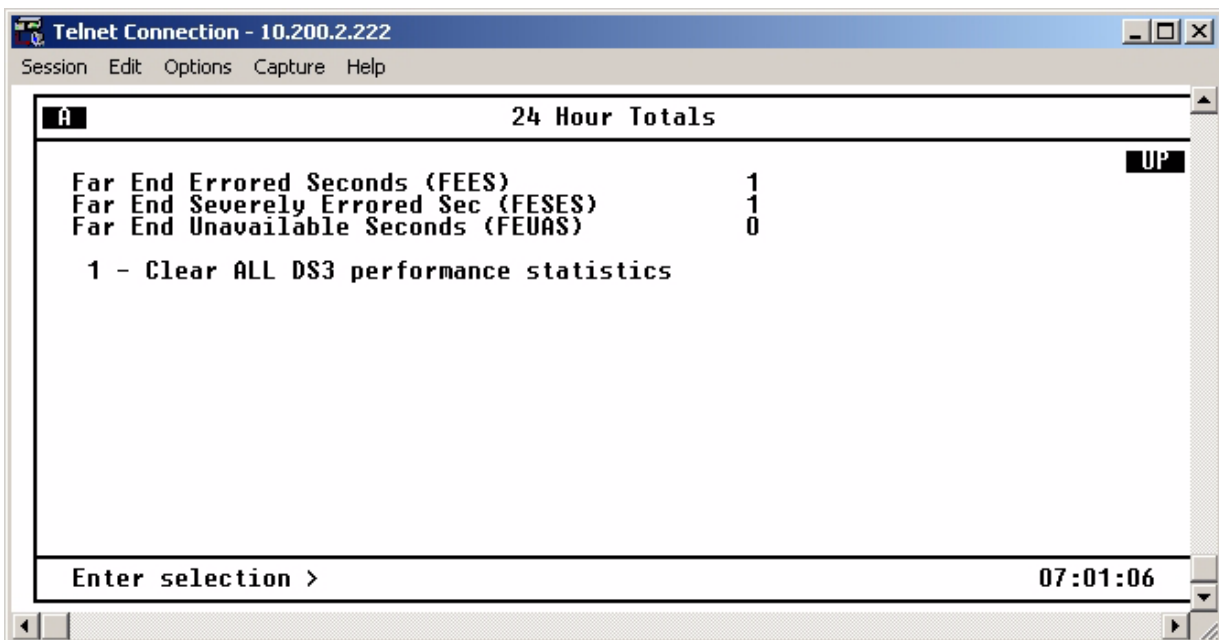
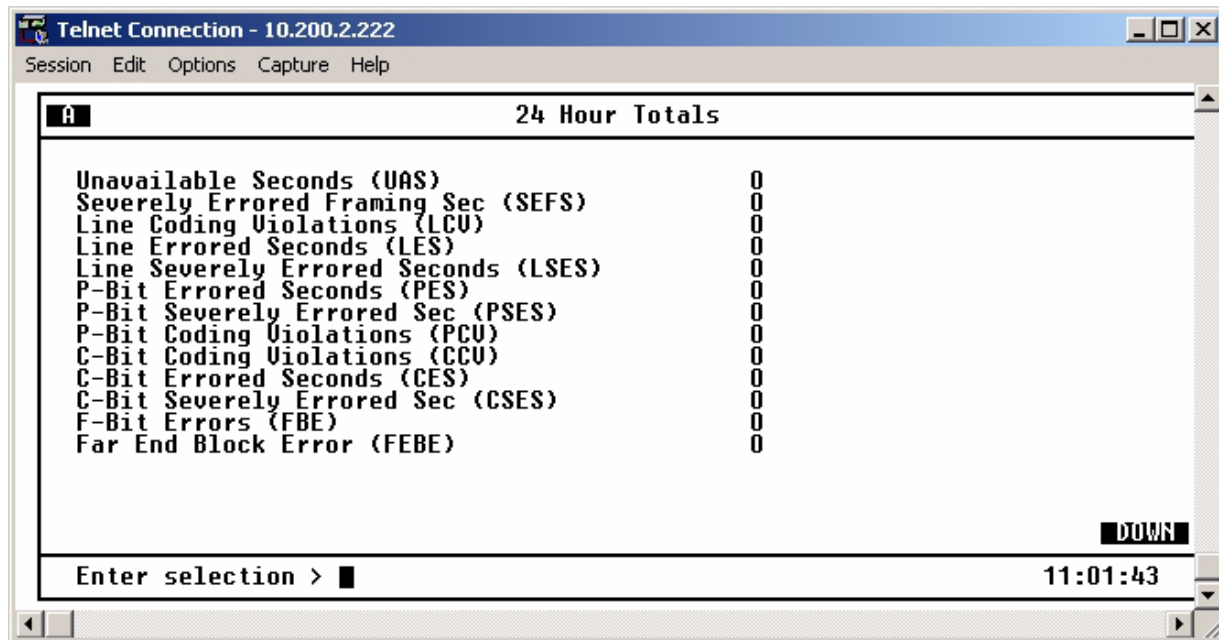

Figure 5-7. DS3 Performance Parameters (Totals)

**Interval starting at:**

This field is the beginning of the 15-minute interval. This field is displayed only in the 24-hour history screen, which gives information for the previous 24 hours divided into 15-minute intervals, as shown in [Figure 5-6](#) on page 5-6.

**Unavailable Seconds (UAS)**

This field is the time in seconds that the network port has been unavailable for data delivery. The T3 link is down or in test or the signaling state is down.

**Severely Errored Framing Seconds (SEFS)**

This field indicates the number of seconds with one or more out-of-frame defects or a detected incoming AIS.

**Line Coding Violation (LCV)**

This field is the number of bipolar violations (BPVs) and excessive zeros (EXZs) that have occurred.

**Line Errored Seconds (LES)**

This field is the number of seconds in which one or more CVs or one or more LOS defects occurred.

**P-Bit Errored Seconds (PES)**

This field indicates the number of seconds with one or more P-Bit Coding Violations (PCVs), one or more out-of-frame defects, or a detected incoming AIS. This count is not incremented when UASs are counted.

**P-Bit Severely Errored Seconds (PSES)**

This field is the number of seconds with 44 or more PCVs, one or more out-of-frame defects, or a detected incoming AIS. This count is not incremented when UASs are counted.

**P-Bit Coding Violations (PCV)**

This field is the number of coding violation (CV) error events that have occurred.

**C-Bit Code Violations (CCV)**

In C-Bit parity mode, this is a count of coding violations reported via the C-Bits or the number of C-Bit parity errors that have occurred.

**C-Bit Errored Seconds (CES)**

This is the number of seconds with one or more CCVs, one or more out-of-frame defects, or a detected incoming AIS. This count is not incremented when UASs are counted.

**C-Bit Severely Errored Seconds (CSES)**

This is the number of seconds with 44 or more CCVs, one or more out-of-frame defects, or a detected incoming AIS. This count is not incremented when UASs are counted.

**F-Bit Errors (FBE)**

This is the number of times an F-bit framing error has occurred.

### Far End Block Error (FEBE)

This field indicates the number of times the far-end unit has received a C-parity or framing error.

### Clear All Local DS3 Statistics/Refresh All Remote Statistics

Use this option to clear or refresh all current information. These selections affect all statistical information, not just the displayed screen. When viewing the 24-Hour History screen, press the DOWN arrow key to access this selection.

## DS2 Statistics

### 24-Hour Alarm History

The MX2800 keeps track of RAI, OOF, and AIS alarms for each of the seven DS2s. View alarm history information in one of the three time period selections, or view a cumulative alarm count. Information in these fields is for the given time period since the last reset. The cumulative alarm count continues indefinitely until Clear All DS2 Alarm Counts is selected. When viewing the 24-Hour History menus, use the UP and DOWN arrow keys to view all three alarm counts (RAI, OOF, and AIS). See [Figure 5-8](#) and [Figure 5-9](#) on page 5-10.

DS2	RAI	OOF	AIS
#1	0	0	0
#2	0	0	0
#3	0	0	0
#4	0	0	0
#5	0	0	0
#6	0	0	0
#7	0	0	0

1 - Clear ALL DS2 alarm counts

Enter selection > 11:06:45

Figure 5-8. DS2 Current 15 Minute Alarm Count Screen

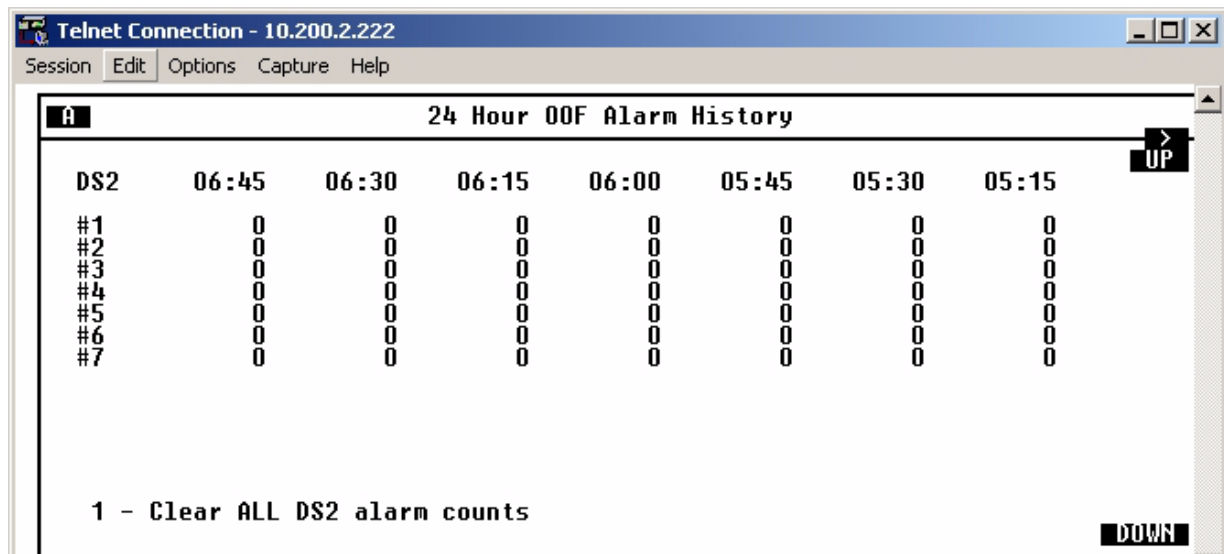
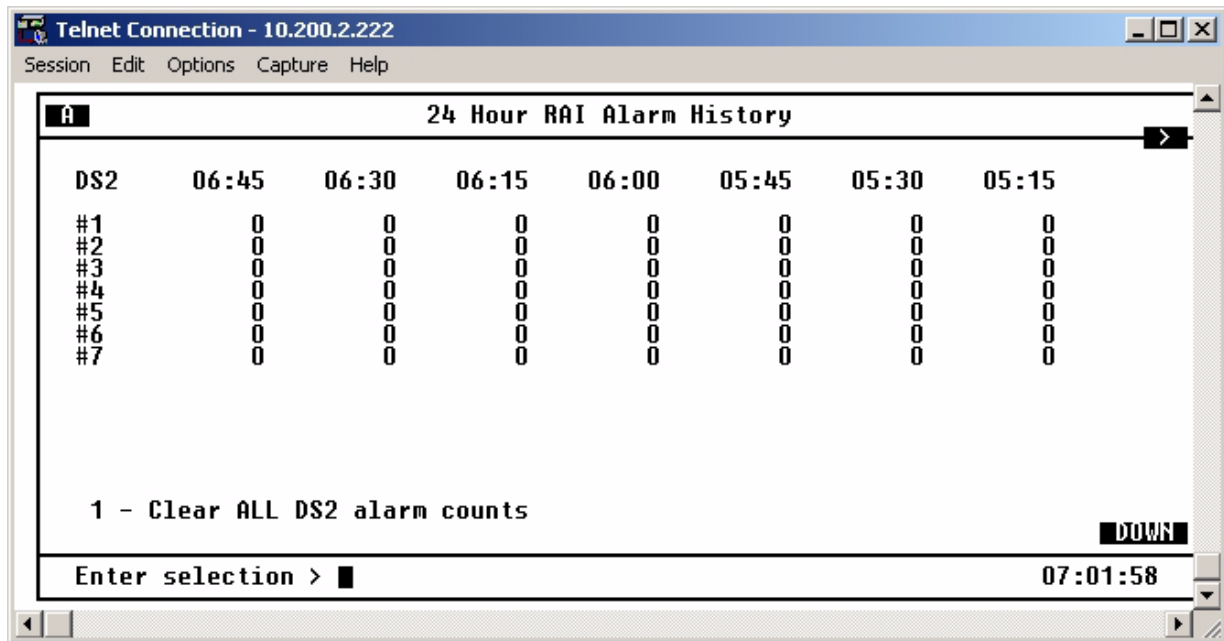
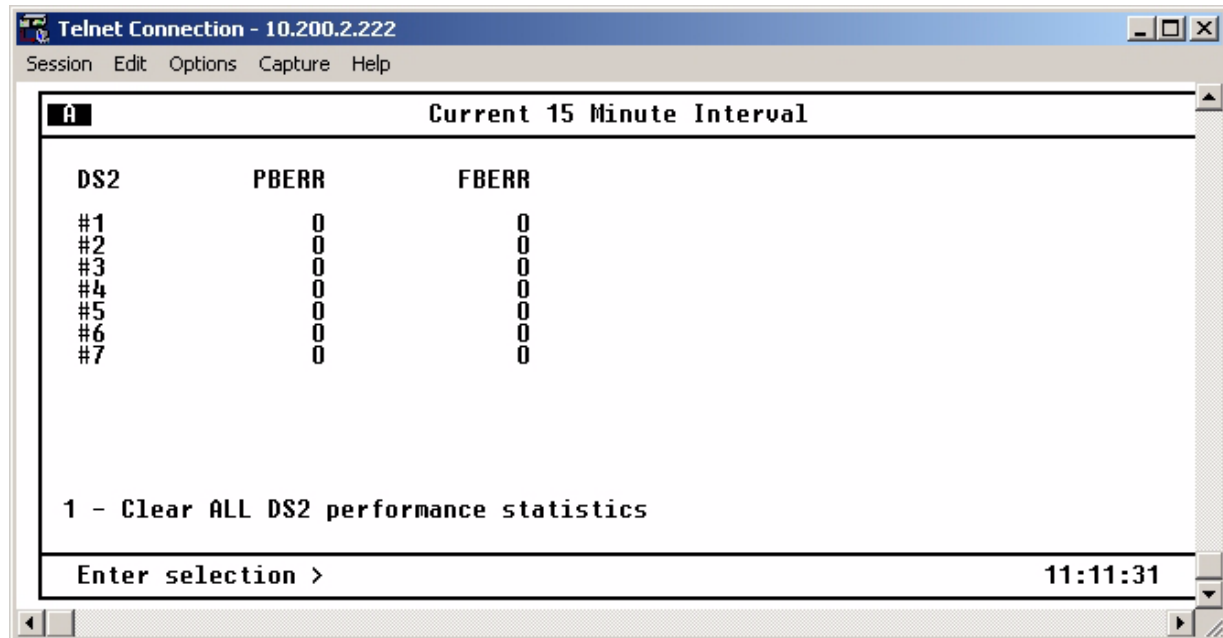

Figure 5-9. DS2 RAI 24-Hour Alarm History

## Performance Parameters

The performance parameters screen displays a count of parity bit errors and frame bit errors for the seven DS2s. View this information in any of the three time period selections. Information in these fields is for the given time period since the last reset. When viewing the 24-hour history statistics screen, use the LEFT and RIGHT arrow keys to scroll through all 96 15-minute intervals; use the UP and DOWN arrow keys to scroll between the PBERR (parity bit error) and FBERR (frame bit error) menus. See [Figure 5-10](#) and [Figure 5-11](#).



DS2	PBERR	FBERR
#1	0	0
#2	0	0
#3	0	0
#4	0	0
#5	0	0
#6	0	0
#7	0	0

1 - Clear ALL DS2 performance statistics

Enter selection > 11:11:31

Figure 5-10. DS2 Performance Parameters (Current 15 Minutes)

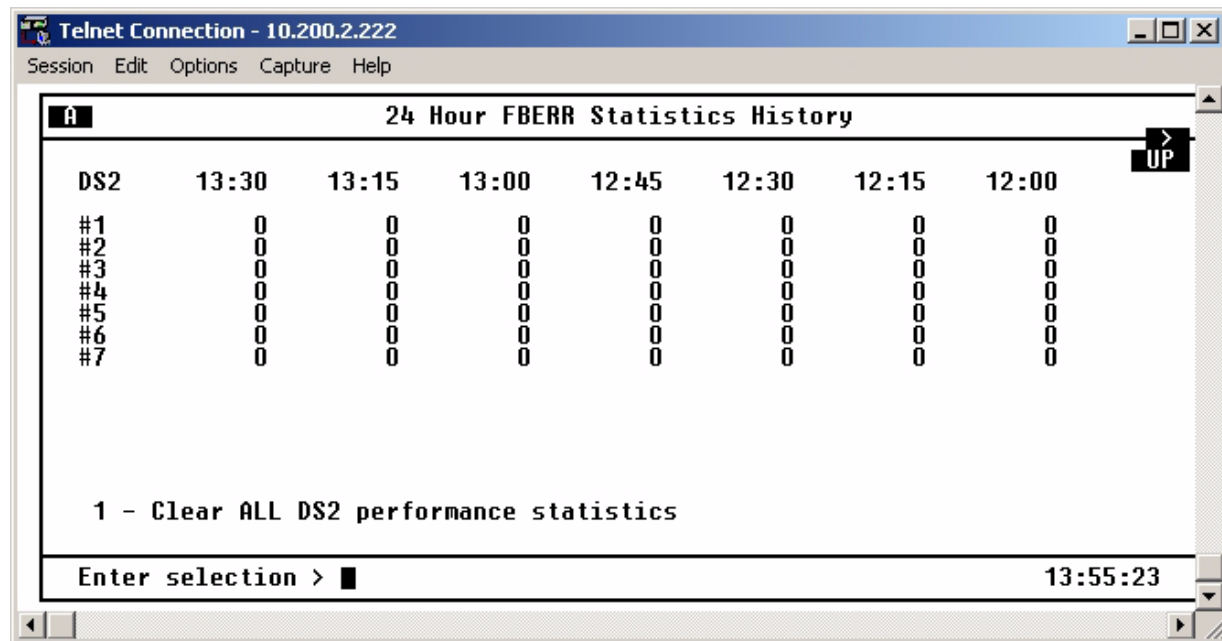
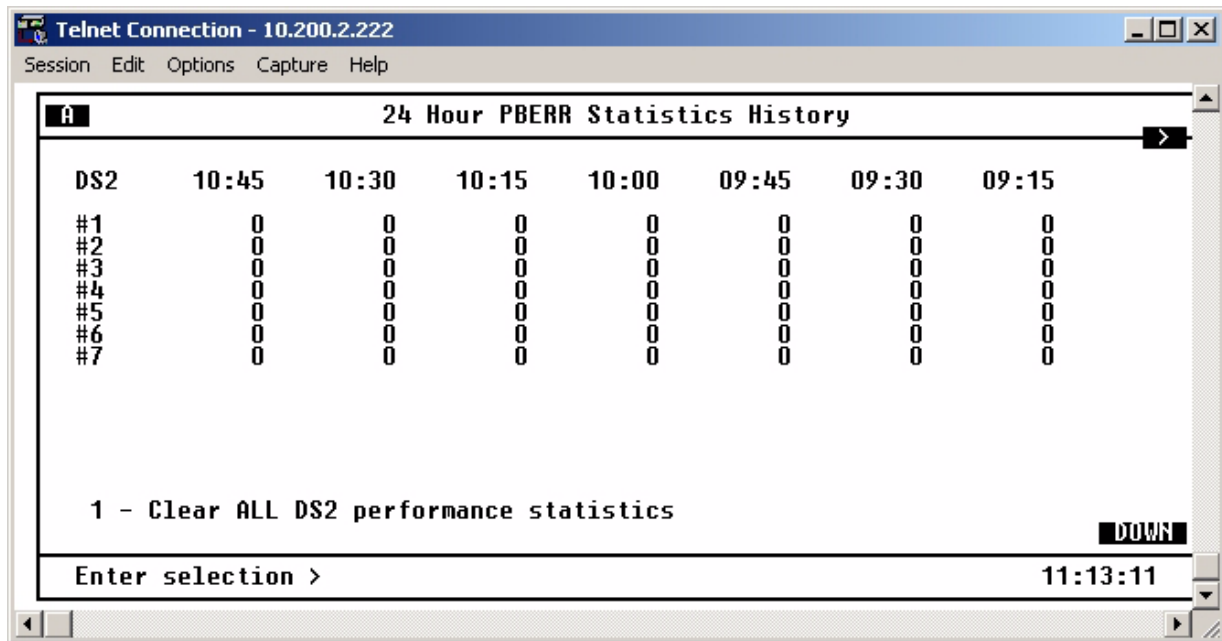

Figure 5-11. DS2 PBERR 24-Hour Alarm History

## T1/E1 Statistics

The MX2800 keeps track of the following statistics for each of the T1s and E1s:

- Loss of Signal Alarms
- Line Coding Violations
- AIS Loop Alarms
- AIS Carrier Alarms
- Errored Seconds
- Severely Errored Seconds

See [Figure 5-12](#). View this information in one of the three time period selections, or view a cumulative alarm count. Information in these fields is for the given time period since the last reset. The cumulative alarm count continues indefinitely until Clear All T1/E1 Alarm Counts, located in each field, is selected.

Performance parameters that are documented for the T1s and E1s are

- Errored Seconds
- Severely Errored Seconds
- Severely Errored Framing Seconds
- Unavailable Seconds
- Degraded Minutes

The current interval, past 24-hours in 15-minute intervals, and 24-hour totals for each of these may be viewed.

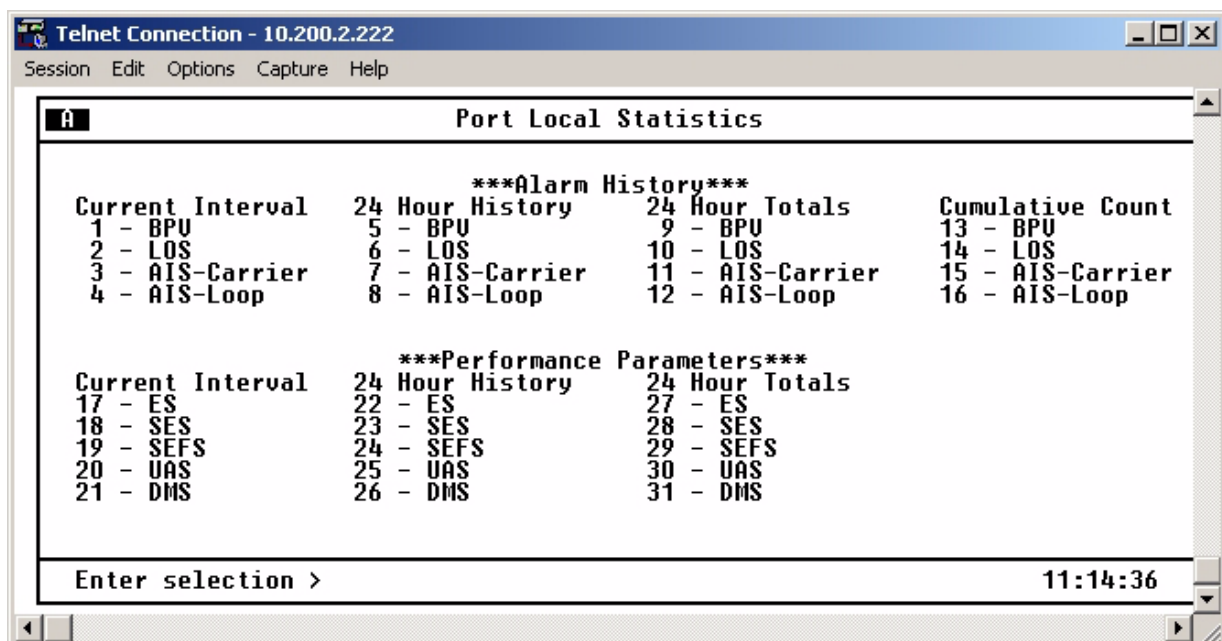

Figure 5-12. T1/E1 Port Local Statistics Menu

### 3. PROTECTION SWITCH STATISTICS

This menu provides statistics regarding protection switches. The number of protection switches that occur within the particular time period are listed. See [Figure 5-13](#) on page 5-14.

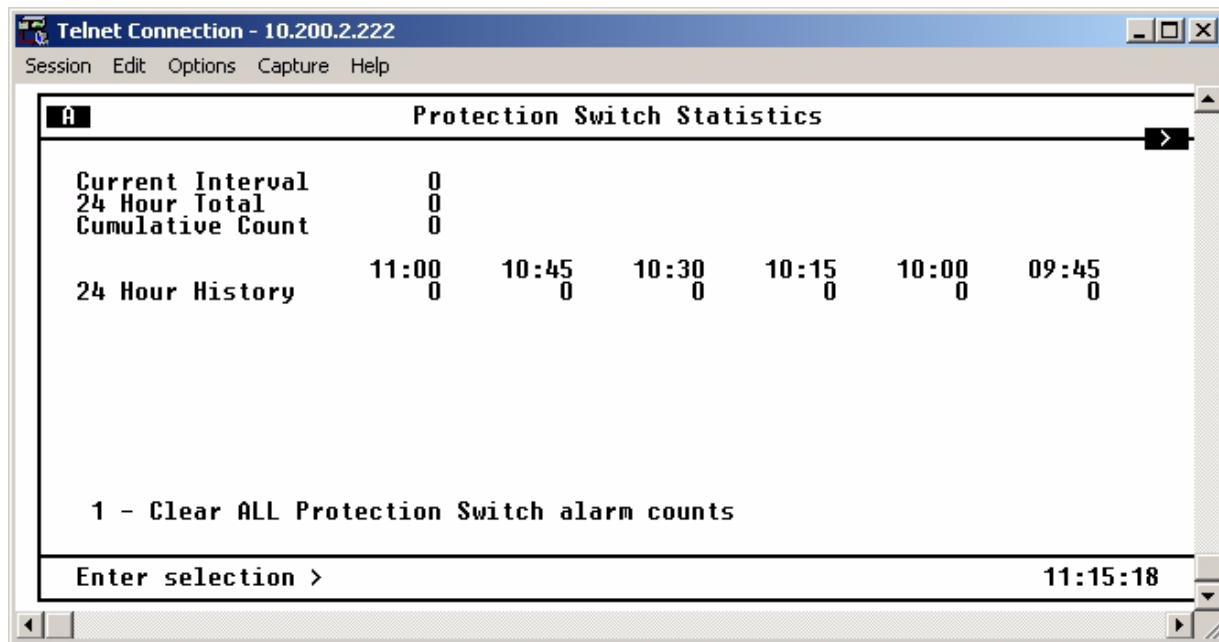

Figure 5-13. Protection Switch Statistics Menu

### Performance Parameters

View performance parameter information for the network in one of the three time period selections. Information in these fields is for the given time period since the last reset. When viewing the 24-Hour History statistics screen, use the LEFT and RIGHT arrow keys to scroll through all 96 15-minute intervals. Clearing protection switch alarm counts will clear the Excessive Switch State, if active.

### Alarm Log

This menu provides a list of the last 200 alarms that have occurred on the MX2800. When the alarm log becomes full, new alarms replace the oldest alarms in a first-in, first-out sequence.

The alarm log is periodically stored in nonvolatile memory. Once every minute, if an alarm has been recorded or if the alarm log has been reset since the last time it was saved, then the alarm log and system configuration are saved to nonvolatile memory. Both the alarm log and system configuration are saved manually when the user executes the Save Configuration & Alarm Log menu function in the Configuration menu. Each time the system powers up, the alarm log is retrieved from non-volatile memory.

A Reset Alarm Log function is accessible from the alarm log menu. This option clears the alarm log. See [Figure 5-14](#) on page 5-15.



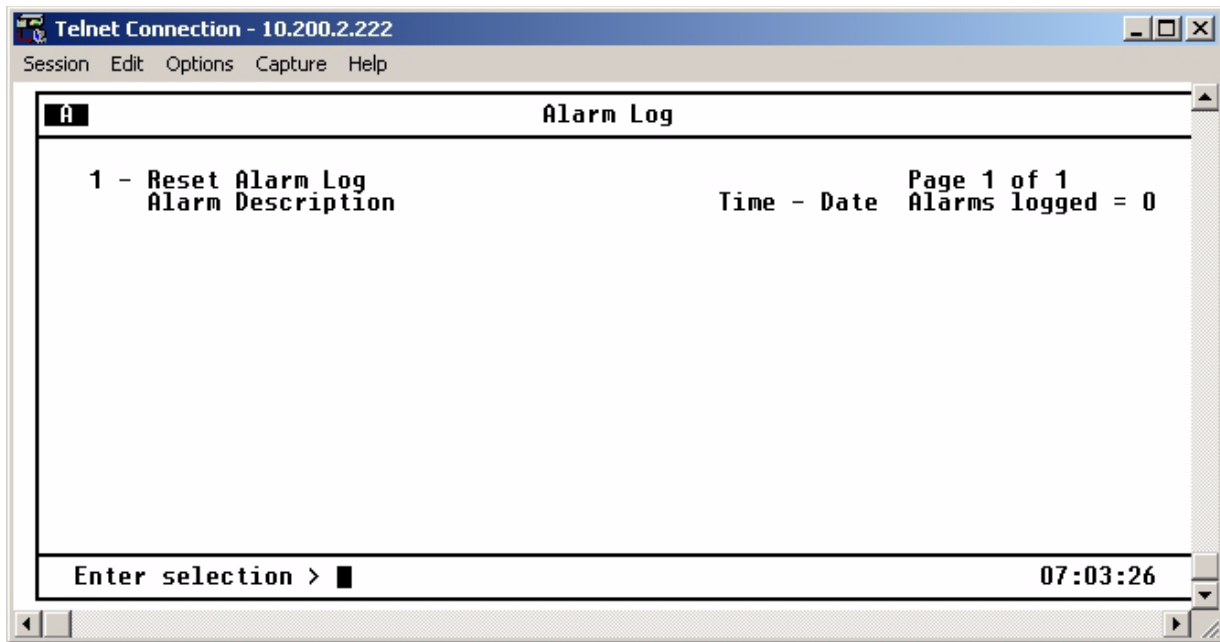

Figure 5-14. Alarm Log

This page is intentionally blank.

# Section 6 Loopbacks

## 1. INTRODUCTION

The Loopback menu initiates loopback tests from the MX2800. [Figure 6-1](#) shows the main Loopback menu. To initiate a loopback, select Loopback Menu.

To locate descriptions of the types of loopback tests that are available, find T1/E1, DS2, or DS3 Loopback descriptions. Next, select by number the type of loopback for a description.

Descriptions and testing diagrams of the loopback tests are provided in the following subsections:

- [T1/E1 Loopbacks](#) on page 6-2
- [DS3 Loopbacks](#) on page 6-6
- [DS2 Loopbacks](#) on page 6-9

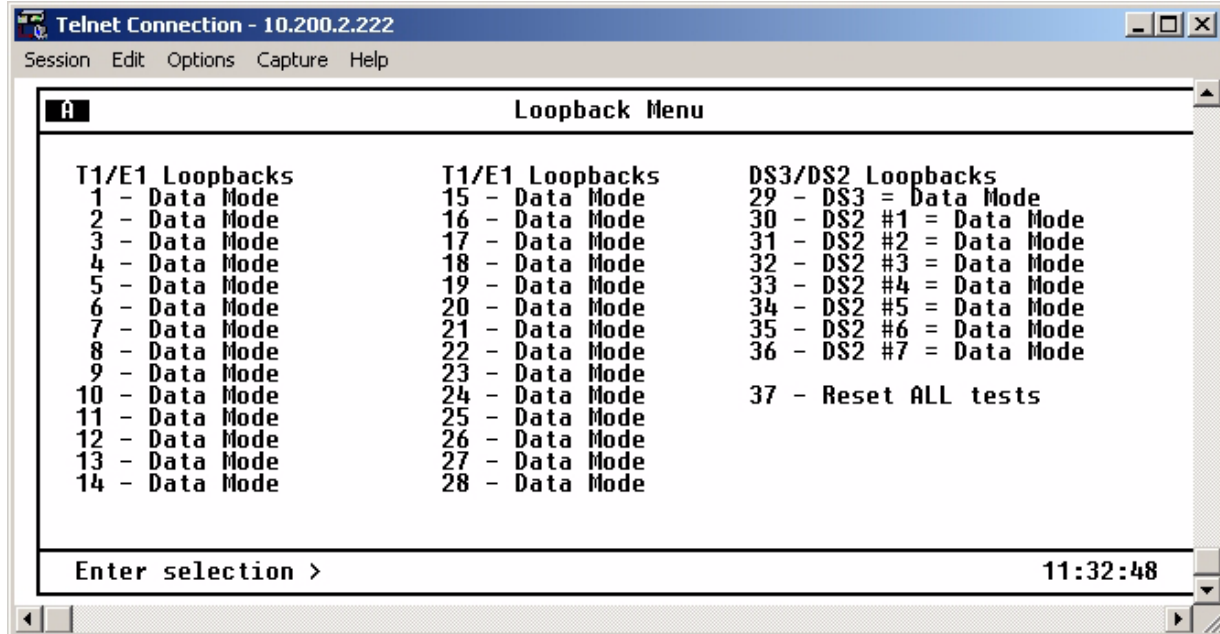

Figure 6-1. Loopback Menu

## 2. T1/E1 LOOPBACKS

Selecting Data Mode Menu from the Loopback menu brings up the control menu shown in [Figure 6-1](#). If initiating a T1/E1 loopback, select the facility number (1-28). A loopback menu for the facility displays a menu of nine types of loopbacks. See [Figure 6-2](#). Select Data Mode to end a loopback test in progress.

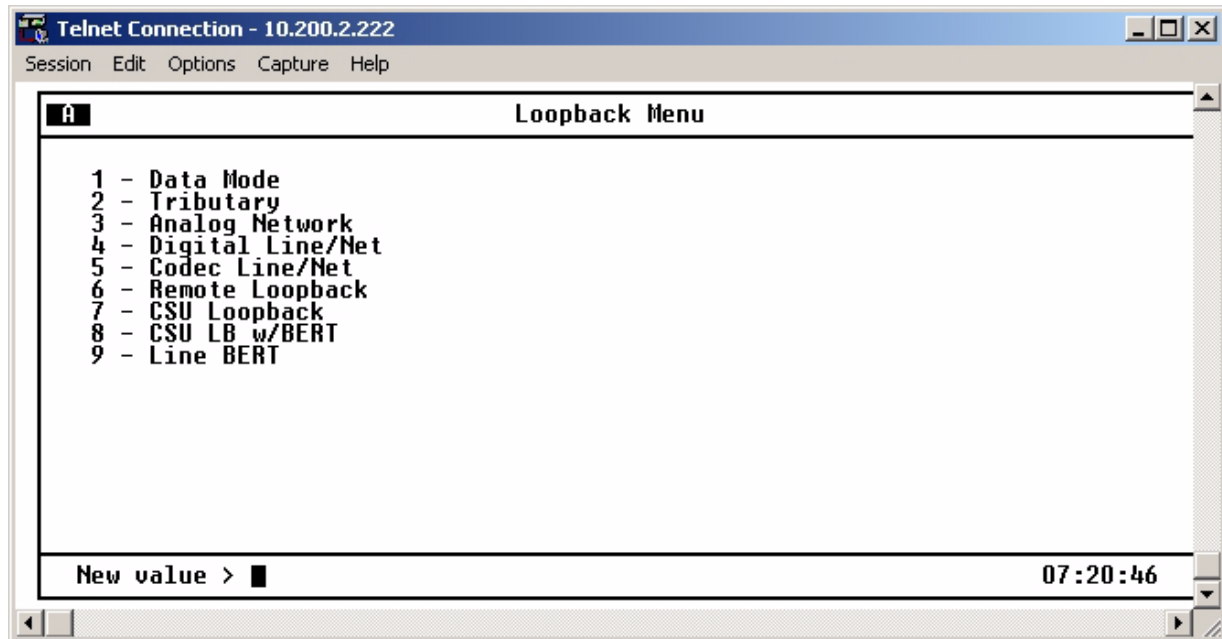

Figure 6-2. Loopback Control Menu

### Data Mode

Selecting the Data Mode from the Loopback Control menu ends any loopback test in progress.

### Tributary

A Tributary loopback loops the selected T1/E1 back to the network (DS3). The T1/E1 is demultiplexed through the M23 and M12/G.747 demultiplexers, looped back, and multiplexed back up through the M12/G.747 and M23 multiplexers. During this loopback, all network receive data is passed to the DSX-1/E1 transmitters, but all data received by the DSX-1/E1 loop side is ignored and substituted with the network data. See [Figure 6-3](#) for an illustration of this test.

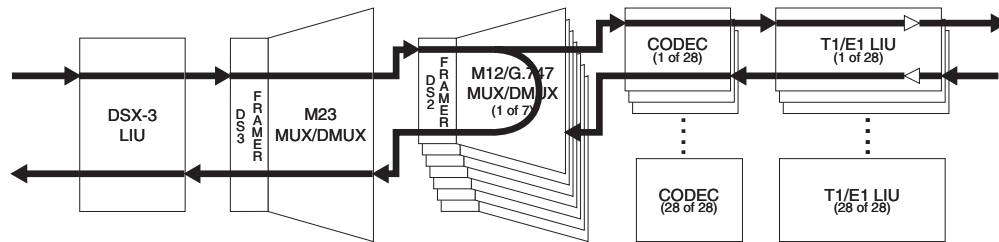

Figure 6-3. Tributary Loopback Test

### Analog Network

An Analog Network loopback test loops the selected T1/E1 back to the network (DS3). The T1/E1 is completely demultiplexed, looped back at the T1/E1 line interface unit (LIU), through the LIU drivers and receivers, and multiplexed back onto the DS3 network stream. See [Figure 6-4](#) for an illustration of this test.

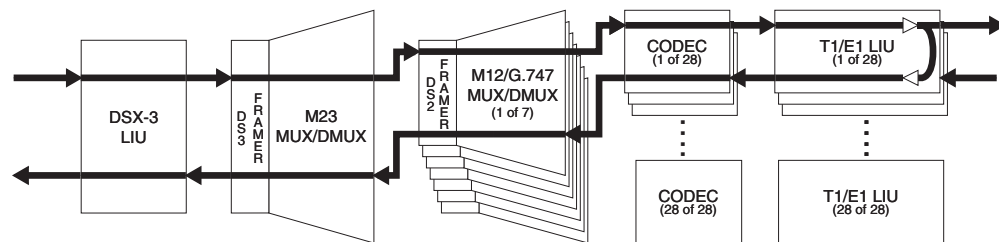

Figure 6-4. Analog Network Loopback

### Digital Line/Net

A Digital Line/Net loopback performs a loopback of the selected T1/E1 in both the network and local loop directions. Both loopbacks occur at the T1/E1 LIU. The network side loopback occurs at the edge of the LIU while the T1/E1 loop side loopback occurs deep into the LIU through the receiver, receive equalizer, transmit jitter attenuator, and the T1/E1 transmit drivers. See [Figure 6-5](#) on page 6-3 for an illustration of this test.

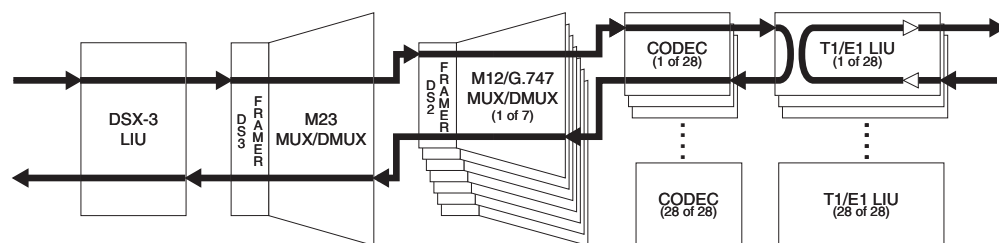
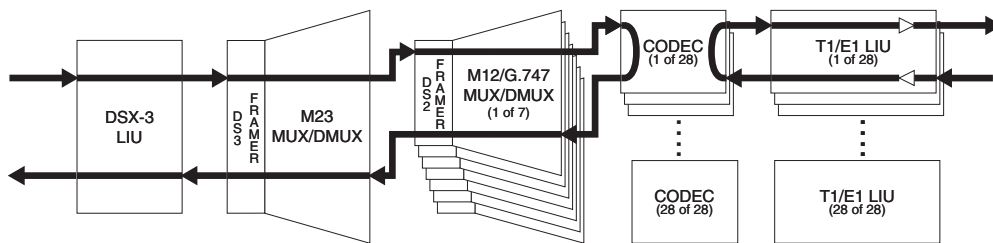

Figure 6-5. Digital Line/Network Loopback

## Codec Line/Net

A Codec Line/Net loopback performs a loopback of the selected T1/E1 in both the network and local loop directions. Both loopbacks occur at the T1/E1 codec. Both the network and the local loop side of the loopback are executed at the edge of the codec, completely testing the M13 mux and the T1/E1 LIU. See [Figure 6-6](#) on page 6-4 for an illustration of this test.



**Figure 6-6. Codec Loopback**

## Remote Loopback

A Remote Loopback performs a loopback of the selected T1/E1 on the far-end M13 multiplexer. If an MX2800 is located at the far end, an Analog Network Loopback is executed when a Remote Loopback is engaged. This loopback is only available when the DS3 is configured for C-bit parity framing since it requires the availability of the far-end alarm and control (FEAC) channel. See ANSI T1.107.

## CSU Loopback

A CSU Loopback enables the MX2800 to generate a CSU loop up pattern (001001...) toward the T1 CSU attached to the selected T1 line for six seconds. After six seconds have elapsed, the pattern ceases; and incoming network traffic is passed through to the CSU device. If the CSU device responded to the CSU loop up pattern, it returns all data back toward the network. A loop down pattern (0000100001...) is generated toward the CSU for 6 seconds when Data Mode is selected.

---

### NOTE

When in CSU Loopback, only the Data Mode for the T1 under test may be selected. Selecting any other option will result in an error message.

---

## CSU Loopback w/BERT

A CSU Loopback w/BERT enables the MX2800 to test the local T1 loop to the CSU using the QRSS pseudorandom bit sequence. When CSU Loopback w/BERT is selected, the MX2800 initiates a CSU loopback toward the CSU attached to the selected T1 line. Six seconds after starting the CSU loop up pattern, the MX2800 ceases sending the CSU loop up pattern and begins sending an unframed QRSS pattern toward the CSU. If the CSU device responded to the CSU loop up pattern, the MX2800 checks the incoming pattern for errors. Additional menu items appear to show the state of pattern synchronization,

error count, and a clear error count option. See [Figure 6-7](#) on page 6-5. Selecting Data Mode will cease the transmission of the QRSS pattern and start transmission of a loop down pattern as previously described.

---

**NOTE**

When in CSU Loopback w/BERT, only the Data Mode for the T1 under test may be selected. Selecting any other option results in an error message.

---

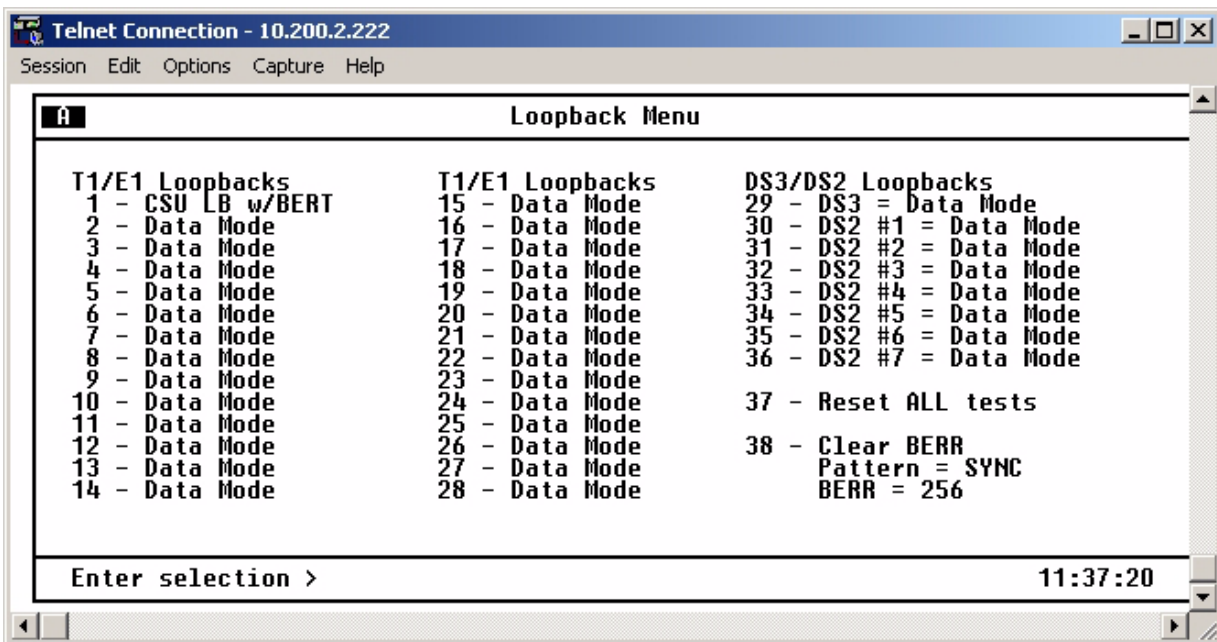

**Figure 6-7. Loopback Menu with BERT Selected**

## Line BERT

A Line BERT enables the MX2800 to perform a “head-to-head” BERT test toward the CSU. Selecting Line BERT replaces all incoming network traffic for the selected T1 with an unframed QRSS pattern toward the CSU. When Line BERT is selected, additional menu items appear and show the state of pattern synchronization, cumulative error count, and a clear error count option. Selecting Data Mode ceases QRSS pattern generation and substitution of the incoming data stream.

---

**NOTE**

When in Line BERT mode, only the Data Mode option for the T1 under test may be selected. Selecting any other option will result in an error message being displayed.

---

---

**NOTE**

Only one T1 port may engage a CSU Loopback, CSU Loopback w/BERT, or a Line BERT. If a CSU Loopback, CSU Loopback w/BERT, or a Line BERT is already active at the time a new CSU Loopback, CSU Loopback w/BERT, or Line BERT is selected, the former test is terminated, and the latter test is engaged.

---

### 3. DS3 LOOPBACKS

After DS3 Loopback is selected, the menu in [Figure 6-8](#) appears. The sections following the figure provide descriptions and illustrations of the testing options. Select Data Mode to end a test in progress.

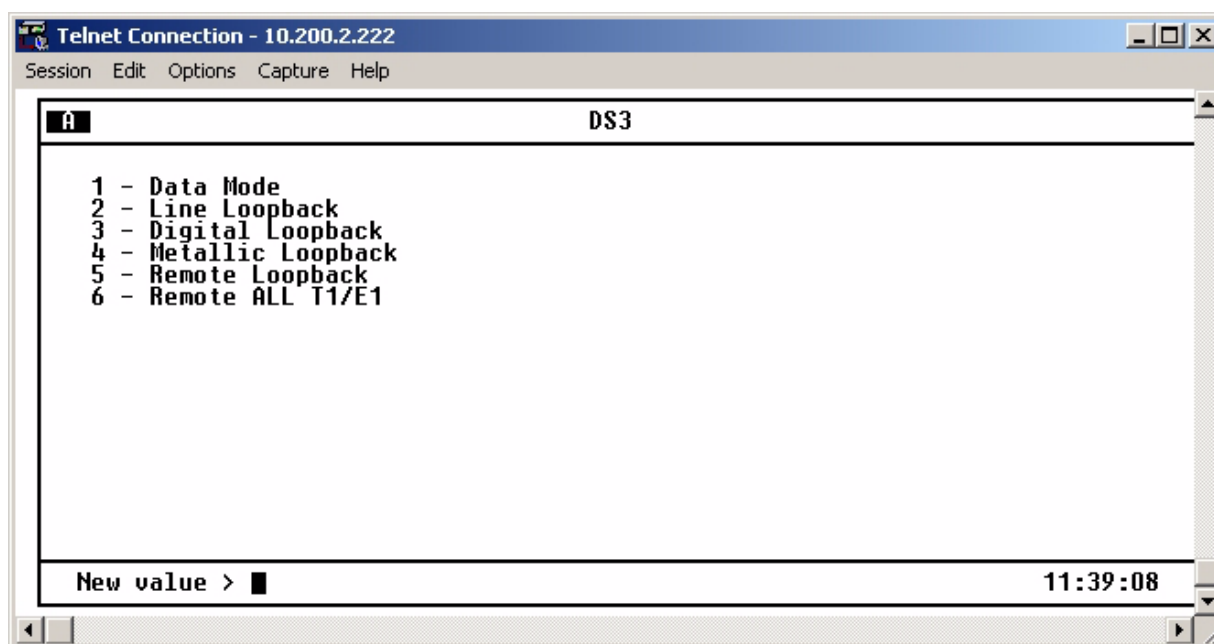

**Figure 6-8. DS3 Loopback Menu**

---

**CAUTION**

If IP forwarding is enabled, a user should not perform a DS3 Loopback from the menus of the far-end (non-LAN end) MX2800. The communication link is over the DS3. If a loopback is performed, communication will be lost with the far-end MX2800. If this happens and a loopback timeout is not active, the user must cycle power to the far-end MX2800 to cancel the loopback and regain access to the shelf.

---



## Line Loopback

Line Loopback performs a loop of the DS3 back to the network. This loopback occurs just prior to the DS3 framer and B3ZS decoder, but it makes full use of the DS3 LIU in both receive and transmit directions; therefore, any coding violations received by the DS3 will be inserted back into the network without modification. See [Figure 6-9](#) on page 6-7 for an illustration of this test.

### NOTE

If a Line loopback is active when the MX2800 is operating in the Local timing mode, the timing source for the DS3 is effectively removed from the circuit. Therefore, it is up to the test equipment or network to provide DS3 timing into the circuit for the duration of the test.

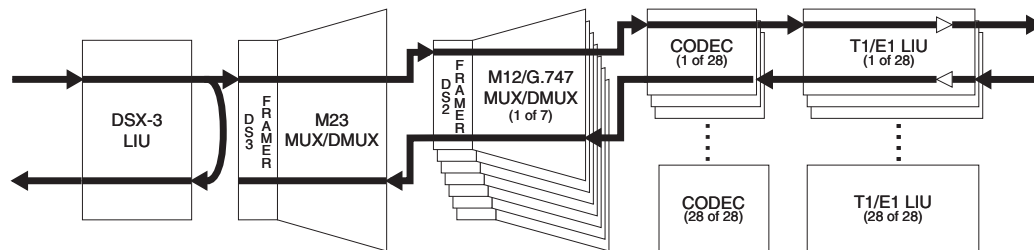

Figure 6-9. Line Loopback Test

## Digital Loopback

A Digital Loopback loops the entire DS3 back to the local loop side. The end effect of this test is a loopback of all T1/E1s after being fully multiplexed and de-multiplexed to and from a DS3. The incoming DS3 data is ignored, and the outgoing DS3 stream is substituted in its place just prior to exiting the DS3 framer. This test is illustrated in [Figure 6-10](#).

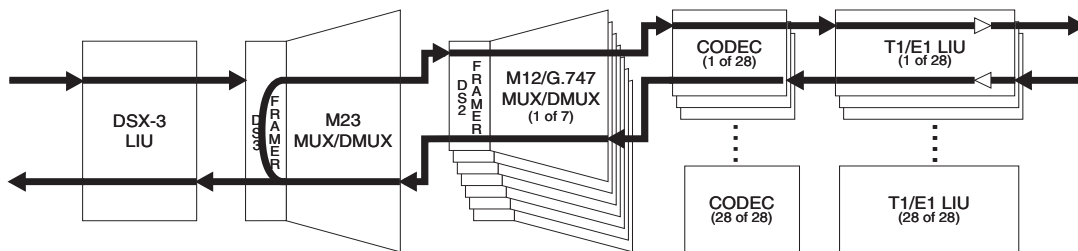

Figure 6-10. Digital Loopback

## Metallic Loopback

A Metallic Loopback test loops the entire DS3 back to the local loop side. The end effect of this test is a loopback of all T1/E1s after being fully multiplexed and de-multiplexed to and from a DS3 and passed through both directions of the DS3 LIU. During this test, the incoming DS3 is disconnected from the DS3 receiver and the outgoing DS3 signal is substituted in its place. See [Figure 6-11](#) on page 6-8 for an illustration of this test.

---

### NOTE

The DS3 Line Length should be set to Short before performing this loopback.

---

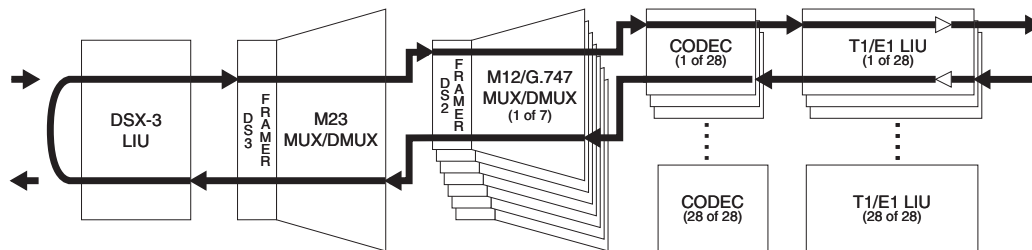

**Figure 6-11. Metallic Loopback Test**

## Remote Loopback

A Remote Loopback performs a loopback on the far-end M13 multiplexer. This loopback is available only when the DS3 is configured for C-bit parity framing since it requires the availability of the FEAC channel. See ANSI T1.107.

---

### NOTE

Local timing must be selected before initiating this loopback. If necessary, it may be returned after loopback has been cancelled.

---

## Remote All T1/E1

A Remote All T1/E1 loopback performs a loopback of all T1/E1 channels on the far-end M13 multiplexer. If an MX2800 is located at the far end, an Analog Loopback is executed on all active channels simultaneously. The form of this loopback code sent to the far-end will depend on the framing mode being used. When in C-Bit parity mode, the MX2800 will send loopback commands over the FEAC channel. When operating in M13 framing mode, the MX2800 will send C-Bit loopbacks at the DS2 level.

## 4. DS2 LOOPBACKS

Once a number has been selected which corresponds with the DS2 to be tested, the DS2 menu in [Figure 6-12](#) on page 6-9 appears. The subsection following the figure provides a description and an illustration of the DS2 Network loopback testing option. Select the appropriate DS2 Data Mode to end a test in progress.

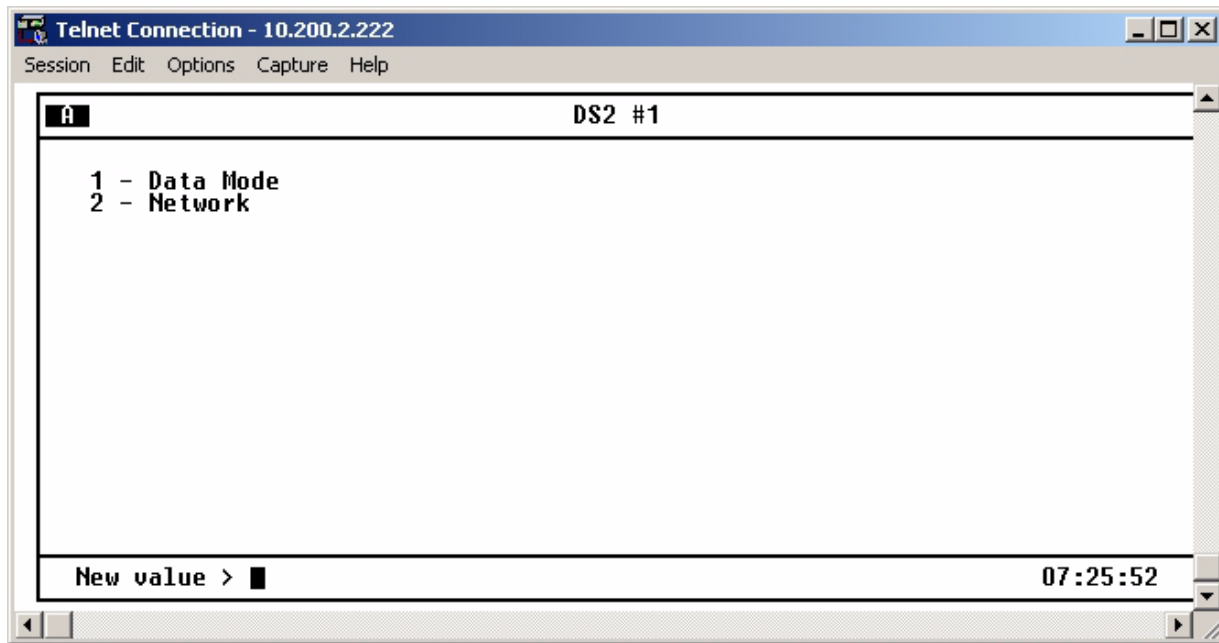

Figure 6-12. DS2 Loopback Menu

### DS2 Network

A DS2 Network loopback test loops the selected DS2 back to the network (DS3) prior to being passed through the M12/G.747 de-multiplexer. All T1/E1s attached to that DS2 will receive data normally, but all data inserted into the T1/E1s attached to the selected DS2 will be ignored and replaced by the incoming DS2 network data. This test is illustrated in [Figure 6-13](#).

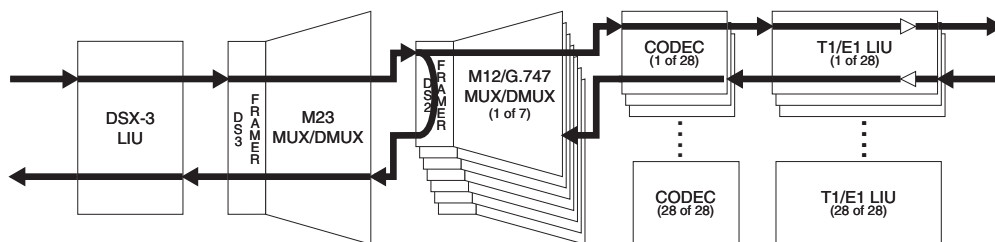

Figure 6-13. DS2 Network Loopback Test

This page is intentionally blank.

## Section 7 Circuit and Network Redundancy

### 1. INTRODUCTION

The MX2800 provides backup measures of protection for circuit failure. The following subsections describe the possible modes of operation:

- *Nonredundant Mode* on page 7-1 offers no backup protection
- *Circuit Failure Recovery Mode* on page 7-2 furnishes backup protection in the event of controller card failure
- *Circuit and Network Failure Recovery Mode* on page 7-3 provides the most complete mode of circuit and network protection.

The descriptions given include illustrations and suggested configuration settings.

---

#### NOTE

The settings may need modification based on your network configuration.

---

### 2. NONREDUNDANT MODE

In Nonredundant Mode, the MX2800 houses only one controller card. There is no failure protection. In the event of a failure, an alarm is initiated and the front panel LEDs reflect the condition. See [Figure 7-1](#) on page 7-1 for an illustration.

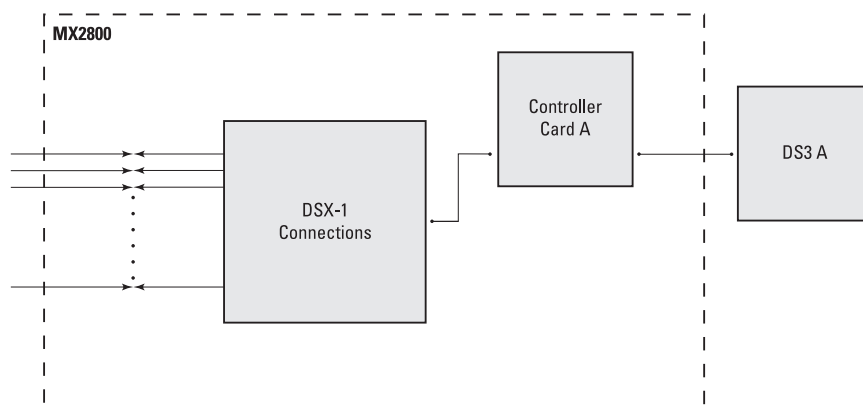

Figure 7-1. Nonredundant Mode

**NOTE**

In this mode, the DS3 must be connected to the **IN** and **OUT** jacks for DS3 A.

**3. CIRCUIT FAILURE RECOVERY MODE**

In Circuit Failure Recovery Mode, two controller cards are installed with an incoming single DS3 line. See [Figure 7-2](#) on page 7-2. In this mode, the MX2800 can continue operating in the event of a controller card failure. When both cards are healthy, the primary card actively processes data while the secondary card stands by and is ready to take over if the first fails. The secondary card continuously monitors the line and remains framed to the incoming signal.

**NOTE**

During a card switch, service interruption occurs on both the DS3 and the DSX1 connections. However, since the secondary controller card remains framed to the incoming signal at all times, it is a minimal interruption.

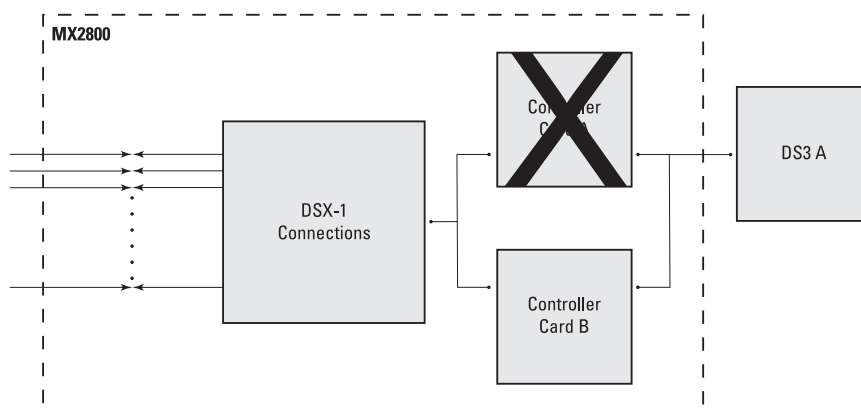

**Figure 7-2. Circuit Failure Recovery Mode**

See [Table 7-1](#) for a list of this mode's configuration requirements.

**Table 7-1. Configuration Requirements for Circuit Recovery**

Selection Path	Recommended Setting
Config > Network Interface > XCV Threshold	1E-3 *
Config > Network Interface > Network Protection	Disabled
Config > Network Interface > Max. Switch Threshold	3

**Table 7-1. Configuration Requirements for Circuit Recovery (Continued)**

Config > Network Interface > Min. Switching Period	10 seconds
Config > T1/E1 Interface > T1/E1 Circuit Protection	Enable all or select the T1/E1s that redundant switching should occur on.
Config > T1/E1 Interface > XCV Threshold	1E-3

\*. This is a critical alarm only when Inactive Card is not installed or is not working.

## 4. CIRCUIT AND NETWORK FAILURE RECOVERY MODE

In this mode, two controller cards are installed and connected to two individual DS3 lines. This is the most complete mode of redundancy. In this mode, the primary controller card is connected to the primary DS3 line and the secondary controller card is connected to the secondary DS3 line. The primary card and line actively transmit data, while the other card and line stand by ready to take over if the first card and line fail.

A feature of the MX2800 is its ability to internally re-route the network connection if a controller card and the opposite network connection fail. For example, in the illustration given in [Figure 7-3](#) on page 7-3, failed DS3 A is connected to healthy Card A and healthy DS3 B is connected to failed Card B. In a case like this, the MX2800 is able to automatically re-route DS3 B to Card A.

The configuration requirements for this mode are the same as the ones given for [Circuit Failure Recovery Mode](#) on page 7-2 except for the Network Protection setting, which must be set to Enable.

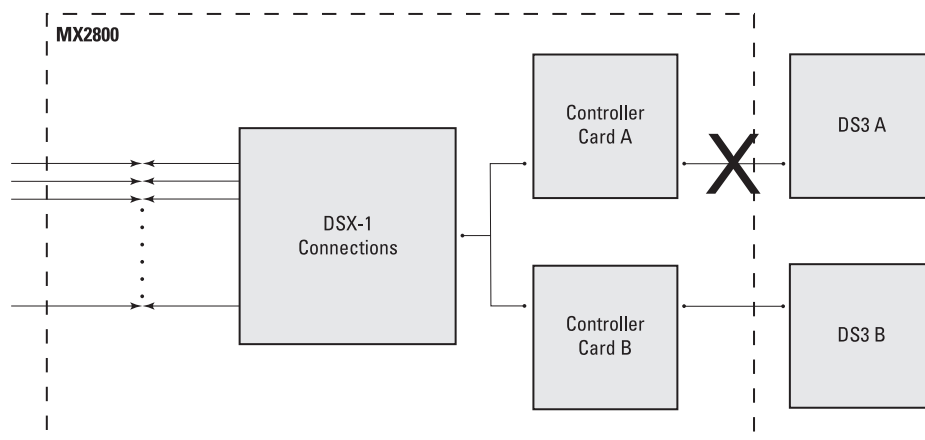

**Figure 7-3. Circuit and Network Failure Recovery Mode**

This page is intentionally blank.



## Section 8 Power Loss Recovery

### 1. INTRODUCTION

The MX2800 provides backup measures of protection for both power supply and power source failure. The following subsections describe the possible modes of operation:

- *Nonredundant Power Mode* on page 8-1 offers no backup protection
- *Power Supply Recovery Mode* on page 8-2 furnishes backup protection in the event of power supply card failure
- *Power Supply and Source Recovery Mode* on page 8-2 provides a backup system for both card and source failure
- *Battery Backup Mode* on page 8-3 offers battery backup in the event of a power outage

### 2. NONREDUNDANT POWER MODE

In Nonredundant Power Mode, the MX2800 houses only one power supply card; and only one power source is available. There is no power failure protection. If a power supply card fails, the unit is down until the card is repaired or replaced. See [Figure 8-1](#) for an illustration.

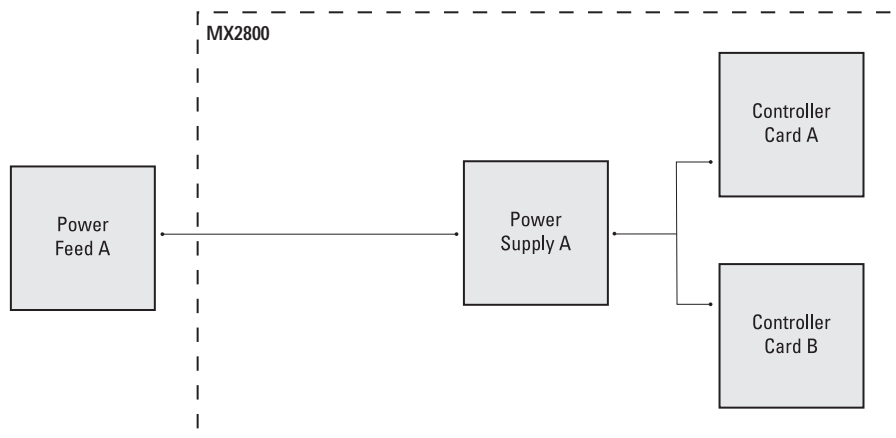

**Figure 8-1. Nonredundant Power Mode**

**NOTE**

Power supplies are hot-swappable.

**3. POWER SUPPLY RECOVERY MODE**

In Power Supply Recovery Mode, two power supply cards are installed and connected to a single power source. See [Figure 8-2](#). In this mode, the MX2800 continues operation in the event of a power supply failure without interrupting service. The power supplies are load sharing, so either power supply can provide power for the entire unit.

**NOTE**

When the unit is configured with dual internal AC power supplies, this is the only power supply protection mode available.

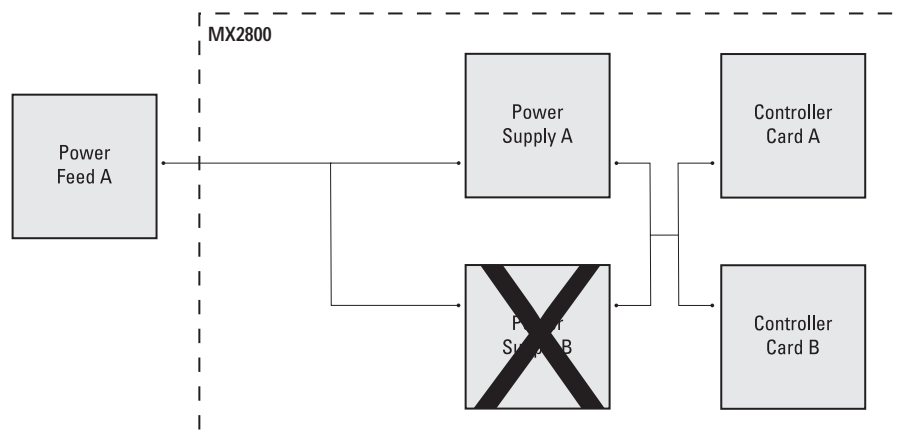

**Figure 8-2. Power Supply Failure Recovery Mode**

**4. POWER SUPPLY AND SOURCE RECOVERY MODE**

In this mode, two power supply cards are installed and are connected to two individual power sources. The MX2800 handles any combination of power source or power supply failure.

Much like the backup design for the controller cards, the MX2800 is able to internally re-route the power source if a power supply card and the opposite power source fail. For example, in [Figure 8-3](#) on page 8-3, failed Power Source A is connected to healthy Card A, and healthy Power Source B is connected to failed Card B. In a case like this, the MX2800 automatically connects Power Source B to Card A.

**NOTE**

This configuration is available only with DC power supplies.

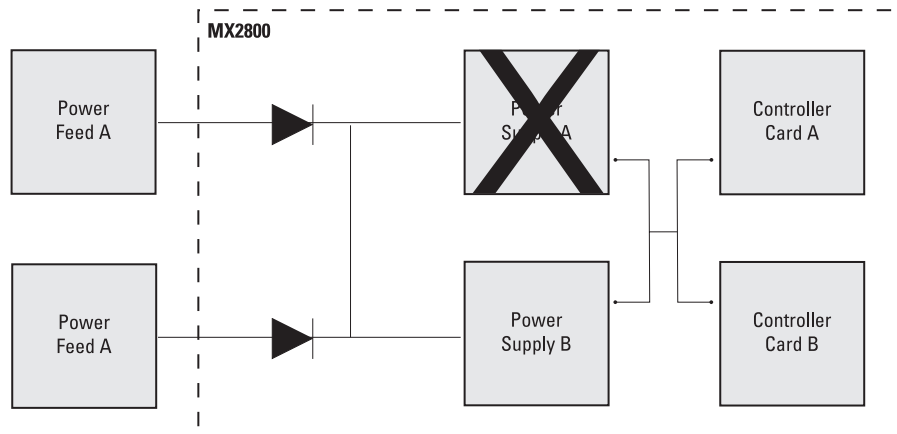

**Figure 8-3. Power Supply and Source Failure Recovery Mode**

## 5. BATTERY BACKUP MODE

With the installation of the ADTRAN Power Supply/Battery Charger (PS/BC) and backup battery pack, the MX2800 can continue operation without service interruption in the event of a power outage. This PS/BC (P/N 4175043L2) provides  $-48$  VDC to the MX2800. It receives 115 VAC through a standard plug and wall socket.

The PS/BC maintains the battery at peak charge ( $-48$  VDC) at all times. If AC power is lost, the unit automatically supplies power from the battery without interrupting service. When AC power returns, the unit switches back to AC power and recharges the battery. For installation instructions, refer to the guide provided with the PS/BC. See [Figure 8-4](#) on page 8-4 for an illustration of this setup.

---

### NOTE

The MX2800 can operate on a fully charged battery for 4 hours without recharging.

---

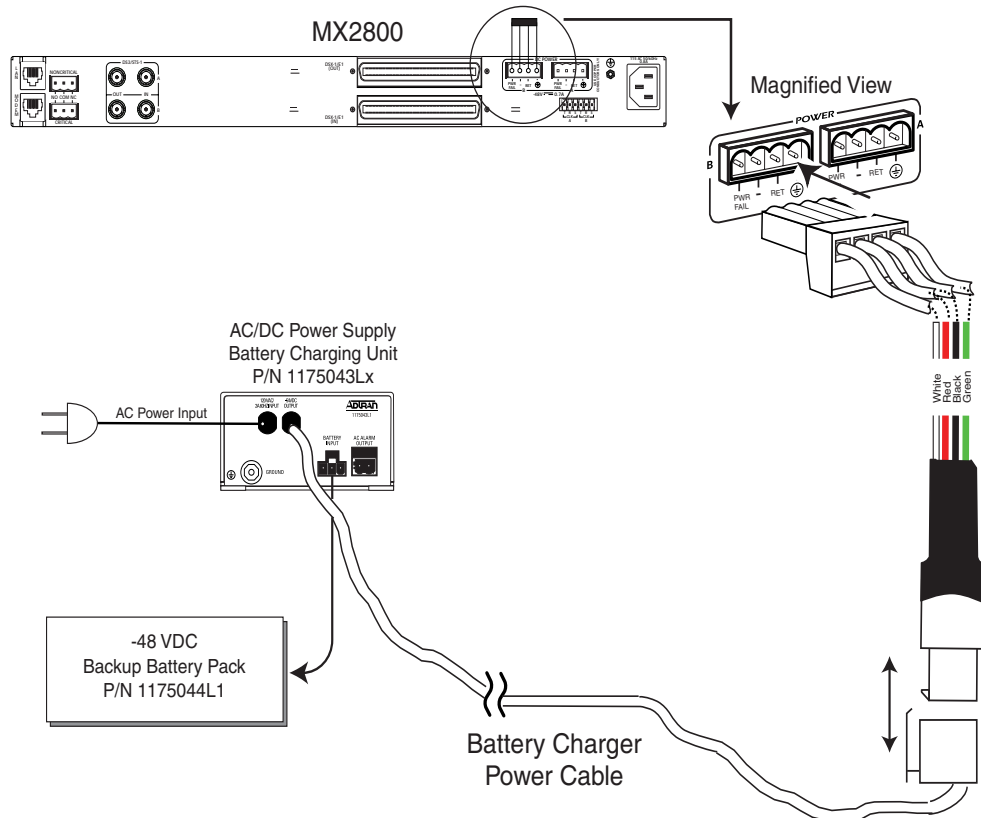

Figure 8-4. Battery Backup System

## Section 9

# Transaction Language 1 (TL1)

### 1. INTRODUCTION

Transaction Language 1 (TL1) is a Bellcore standard used in the input and output messages that pass between Operations Systems (OS) and Network Elements (NE) in telecommunication networks. It was developed to standardize equipment surveillance and memory administration and to test with a common format.

This release of TL1 primarily supports the interactive and autonomous retrieval of system events as part of a valid TL1 session.

### 2. OVERVIEW

TL1 is an ASCII-based language that supports both command-response and autonomous (NE) message generation. Commonly, TL1 is used over an X.25 packet network but is completely independent of any physical layer protocols. For the MX2800, TL1 is implemented as a Telnet session or “RAW TCP” session running over either Ethernet or PPP.

To successfully initiate a TL1 session, the unit must be properly configured for an Ethernet (LAN) or PPP connection. A valid IP address, gateway address, and subnet mask are required. Refer to *System Management* on page 3-16. User authentication is also required. An account must be set up before initiating a TL1 session.

An account may be set up via the VT100 menus (Configuration/System Management/System Security/User Account Management.) An account includes a username, password, and privileges. The privileges are as follows:

- Admin privileges allow the user to use all supported commands.
- Guest privileges allow the user only to activate the TL1 session, cancel a TL1 session, and retrieve specific system information.
- Interface privileges allow the user to use all supported commands except modifying the user account information, setting the MX2800 date and time, configuring alarm relays, and operating loopbacks.
- Test privileges allow the user to use all supported commands except modifying the user account information, configuring alarm relays, and setting the MX2800 date and time.

The TL1 account privileges are detailed in [Table 9-1](#) on page 9-2.

**Table 9-1. TL1 Account Privileges**

TL1 Command	Guest	Interface	Test	Admin
ACT-USER	X	X	X	X
ALW-MSG-rr	X	X	X	X
CANC-USER	X	X	X	X
DLT-USER-SECU				X
ED-USER-SECU				X
ED-rr (related to loopbacks)			X	X
ED-rr (configuring alarm relays)				X
ED-rr (all remaining)		X	X	X
ENT-USER-SECU				X
INH-MSG-rr	X	X	X	X
OPR-LPBK			X	X
REPT-STAT	X	X	X	X
RLS-LPBK			X	X
RTRV-ALM-rr	X	X	X	X
RTRV-COND-rr	X	X	X	X
RTRV-HDR	X	X	X	X
RTRV-rr	X	X	X	X
RTRV-SYS	X	X	X	X
RTRV-USER-SECU				X
RTRV-VER	X	X	X	X
SET-DAT				X

To bring up a TL1 Telnet connection (up to eight may be active), a Telnet client requests a connection on TCP port 3116 (port 2024 is used for “RAW TCP” socket access). Once the Telnet connection is established, it is necessary to initiate a TL1 session. Establishing a TL1 session involves successful user authentication. Until a TL1 session is established, all commands other than those used to initiate or terminate a session are denied. Autonomous messaging is also disabled. For information on using the Act-User command to initiate a TL1 session, refer to *TL1 Commands* on page 9-5.

---

**NOTE**

If RADIUS authentication is enabled, refer to *RADIUS Authentication* on page 3-27, the MX2800 attempts to use RADIUS to authenticate TL1

users. If the RADIUS server presents a login challenge which requires a response, then the TL1 user re-enters the ACT-USER command, supplying the appropriate response as the password. Challenges and other reply messages returned from the RADIUS server are displayed as comments in the response message from the MX2800.

---

### 3. TL1 MESSAGES

As stated earlier, TL1 messages are either part of a command-response exchange or are generated autonomously. A TL1 command has the general format as follows:

```
<verb>[-<mod1>[-<mod2>]] :<tid>:<aid>:<ctag>:<general block>:<keyword
block>: <state block>;
```

Refer to *TL1 Commands* on page 9-5 for a list of TL1 commands supported by the MX2800.

### TL1 Responses

There are three types of TL1 responses:

- Acknowledgment messages
- Output Response messages
- Autonomous messages

#### Acknowledgment Messages

Acknowledgment messages are brief output messages generated in response to received TL1 commands. The MX2800 currently supports two types of acknowledgment messages:

- In Progress (IP)
- All Right (OK)

#### In Progress

The IP acknowledgment message is usually generated as an interim response message to indicate that a message has been received and the command is being executed. IP messages have the following general format:

```
IP <ctag><cr><lf>
<
```

#### All Right

The OK acknowledgment message indicates that a command has been received, and the required action was initiated and completed. This message has the following general format:

```
OK <ctag><cr><lf>
<
```

## Output Response Messages

Output Response messages are generated in response to received commands. Output Response Messages have the following general format:

```
<cr><lf><lf>
^^^<tid>^<yr>--<mo>--<day>^<hr>:<min>:<sec><cr><lf>
M^^<ctag>^<completion code><cr><lf>
^^^<errcode><cr><lf>;
```

For the MX2800, the Completion Code field contains one of the following values:

- Comply indicates a successful execution of the received command.
- Deny indicates denial of the received command.

When the received command is denied, the line in the message following the Completion Code line contains a four letter error code. Refer to [TL1 Error Codes](#) on page 9-17 for an indication of the possible MX2800 error codes.

The MX2800 specifically uses quoted line(s) in the response message of successfully executed RTRV-ALM commands. The quoted line format is as follows:

```
<aid>:<ntfcncde>,<condtype>,<srveff>,<ocrdat>,<ocrtm>,<locn>...
```

The NTFNCNDE field contains one of the following values:

- MN - Minor
- MJ - Major
- CR - Critical

See the condition types listed in [Table 9-3](#) on page 9-12 for possible MX2800 CONDTYPE codes.

## Autonomous Messages

The Autonomous message is sent from the NE to the OS and is not associated with any explicit input message. The MX2800 uses this message to exclusively report alarmed and non-alarmed events. An autonomous message has the following general format:

```
<cr><lf><lf>
^^^<tid>^<yr>--<mo>--<day>^<hr>:<min>:<sec><cr><lf>
<alarm code>^<atag>^<verb>[ ^<mod1>[ ^<mod2>] ]<cr><lf>
^^^" <aid>:<message parameters>"<cr><lf>;
```

Possible values for the Alarm Code field include the following:

- \*C - Critical Alarm
- \*\* - Major Alarm
- \* - Minor Alarm
- A - Non-alarm
- Null - (blank)



The MX2800 specifically uses quoted line(s) in REPT-ALM and REPT-EVT Autonomous messages. The REPT-ALM message has the following quoted line format:

```
<aid>:<ntfcncde>,<condtype>,<srveff>,<ocrdat>,<ocrtm>,<locn>...
```

The NTFNCNDE field contains one of the following values:

- CL indicates alarm cleared.
- TC indicates transient condition.
- MN indicates minor.
- MJ indicates major.
- CR indicates critical.

The REPT-EVT message has the following quoted line format:

```
<aid>:<ntfcncde>,<condeff>,<srveff>,<ocrdat>,<ocrtm>,<locn>...
```

The CONDEFF field will contain one of the following values:

- CL indicates standing condition cleared.
- SC indicates standing condition raised.
- TC indicates transient condition.

For possible CONDTYPE codes for both REPT-ALM and REPT-EVT quoted lines, see the condition types listed in [Table 9-3](#) on page 9-12 and [Table 9-4](#) on page 9-16, respectively.

Refer to the section [TL1 Autonomous Messages](#) on page 9-11 for a list of Autonomous messages currently supported by the MX2800.

## 4. TL1 COMMANDS

As stated in [TL1 Messages](#) on page 9-3, the general format for a TL1 command is as follows:

```
<verb>[-<mod1>[-<mod2>]]:<tid>:<aid>:<ctag>:<general block>:<keyword block>: <state block>;
```

Areas of concentration for TL1 support in the MX2800 include session initiation, session termination, and system event reporting. [Table 9-2](#) lists the commands currently supported by the MX2800.

---

### NOTE

The Target ID (tid) is the same as the Unit ID. Refer to the [Unit ID](#) on page 3-36.

---

Table 9-2. TL1 Commands

<b>ACT-USER:&lt;tid&gt;:&lt;username&gt;:&lt;ctag&gt;::&lt;password&gt;;</b>	
Description	Initiates a TL1 session
TID	Target ID
AID	Username (must be present in the User Account Management table)
CTAG*	Transaction Number (integer)
PARAM1	Password for associated username
<b>ALW-MSG-{EQPT rr ALL}:&lt;tid&gt;::&lt;ctag&gt;;</b>	
Description	Allows the transmission of the requested autonomous alarm(s)
MOD2	Specifies what entity type to allow: <ul style="list-style-type: none"> <li>• EQPT General Equipment Unit</li> <li>• rr Facility or Circuit (i.e. T1, T2, T3)</li> <li>• ALL All entity types</li> </ul>
TID	Target ID
CTAG*	Transaction Number (integer)
PARAM1*	Specifies what notification code to allow: <ul style="list-style-type: none"> <li>• MN minor</li> <li>• MJ major</li> <li>• CR critical</li> <li>• ALL all notification codes</li> </ul>
<b>CANC-USER:&lt;tid&gt;::&lt;ctag&gt;;</b>	
Description	Terminates a TL1 session
TID	Target ID
AID*	Username (must be present in the User Account Management table)
CTAG*	Transaction Number (integer)
<b>ED-USER-SECU:&lt;tid&gt;:&lt;username&gt;:&lt;ctag&gt;::&lt;password&gt;,,&lt;privileges&gt;;</b>	
Description	Edits the requested user's account
TID	Target ID
AID	Username
CTAG*	Transaction Number (integer)
PARAM2	User's new password
PARAM4	User's new privileges: <ul style="list-style-type: none"> <li>• 0 disabled</li> <li>• 1 guest</li> <li>• 2 interface</li> <li>• 4 test</li> <li>• 8 admin</li> </ul>

**Table 9-2. TL1 Commands (Continued)**

<b>ENT-USER-SECU:&lt;tid&gt;:&lt;username&gt;:&lt;ctag&gt;::&lt;password&gt;,,&lt;privileges&gt;;</b>	
Description	Adds the requested user to the User Account Management table
TID	Target ID
AID	Username
CTAG*	Transaction Number (integer)
PARAM1	User's password
PARAM3	User's privileges: <ul style="list-style-type: none"> <li>• 0 disabled</li> <li>• 1 guest</li> <li>• 2 interface</li> <li>• 4 test</li> <li>• 8 admin</li> </ul>
<b>DLT-USER-SECU:&lt;tid&gt;:&lt;username&gt;:&lt;ctag&gt;;</b>	
Description	Removes the requested user from the User Account Management table
TID	Target ID
AID	Username
CTAG*	Transaction Number (integer)
<b>INH-MSG-{EQPT rr ALL}:&lt;tid&gt;::&lt;ctag&gt;:&lt;ntfncde&gt;;</b>	
Description	Inhibits the transmission of the requested autonomous alarm(s)
MOD2	Specifies what entity type to inhibit: <ul style="list-style-type: none"> <li>• EQPT General Equipment Unit</li> <li>• rr Facility or Circuit (i.e. T1, T2, T3)</li> <li>• ALL All entity types</li> </ul>
TID	Target ID
CTAG*	Transaction Number (integer)
PARAM1*	Specifies what notification code to inhibit: <ul style="list-style-type: none"> <li>• MN minor</li> <li>• MJ major</li> <li>• CR critical</li> <li>• ALL all notification codes</li> </ul>
<b>RTRV-HDR:&lt;tid&gt;::&lt;ctag&gt;;</b>	
Description	Replies with a normal "COMPLD" response
TID	Target ID
CTAG*	Transaction Number (integer)

**Table 9-2. TL1 Commands (Continued)**

<b>RTRV-VER:&lt;tid&gt;::&lt;ctag&gt;;</b>	
Description	Retrieves the current software revision
TID	Target ID
CTAG*	Transaction Number (integer)
<b>RTRV-SYS:&lt;tid&gt;::&lt;ctag&gt;;</b>	
Description	Retrieves the system identifier string
TID	Target ID
CTAG*	Transaction Number (integer)
<b>RTRV-USER-SECU:&lt;tid&gt;::&lt;ctag&gt;;</b>	
Description	Retrieves the current list of users from the TL1 users table
TID	Target ID
CTAG*	Transaction Number (integer)
<b>RTRV-ALM-{EQPT rr ALL}:&lt;tid&gt;::&lt;ctag&gt;;</b>	
Description	Retrieves the requested alarm status
MOD2	Specifies what entity type to query: <ul style="list-style-type: none"> <li>• EQPT    General Equipment Unit</li> <li>• rr       Facility or Circuit (i.e. T1, T2, T3)</li> <li>• ALL     All entity types</li> </ul>
TID	Target ID

**Table 9-2. TL1 Commands (Continued)**

AID*	<p>Identifies the component to which the desired alarm pertains. Identifiers are integers and are dependent on the entity specified in “MOD2” as follows:</p> <p>for EQPT:</p> <table data-bbox="641 401 1279 630"> <tr><td>401</td><td>Generic</td></tr> <tr><td>402</td><td>Control Card A</td></tr> <tr><td>403</td><td>Control Card B</td></tr> <tr><td>404</td><td>Power Supply A</td></tr> <tr><td>405</td><td>Power Supply B</td></tr> <tr><td>ALL</td><td>all EQPT identifiers (default selection)</td></tr> </table> <p>for T1:</p> <table data-bbox="641 678 1230 865"> <tr><td>101</td><td>DS1#1</td></tr> <tr><td>102</td><td>DS1#2</td></tr> <tr><td>.</td><td></td></tr> <tr><td>128</td><td>DS1#28</td></tr> <tr><td>ALL</td><td>all DS1 circuits (default selection)</td></tr> </table> <p>for T2:</p> <table data-bbox="641 915 1230 1102"> <tr><td>201</td><td>DS2#1</td></tr> <tr><td>202</td><td>DS2#2</td></tr> <tr><td>.</td><td></td></tr> <tr><td>207</td><td>DS2#7</td></tr> <tr><td>ALL</td><td>all DS2 circuits (default selection)</td></tr> </table> <p>for T3:</p> <table data-bbox="641 1152 1230 1299"> <tr><td>301</td><td>DS3#1</td></tr> <tr><td>302</td><td>DS3 (Control Card A)</td></tr> <tr><td>303</td><td>DS3 (Control Card B)</td></tr> <tr><td>ALL</td><td>all DS3 circuits (default selection)</td></tr> </table> <p>for ALL:</p> <table data-bbox="641 1350 1230 1419"> <tr><td>x</td><td>specific identifier (e.g. 1, 28, etc.)</td></tr> <tr><td>ALL</td><td>all identifiers (default selection)</td></tr> </table>	401	Generic	402	Control Card A	403	Control Card B	404	Power Supply A	405	Power Supply B	ALL	all EQPT identifiers (default selection)	101	DS1#1	102	DS1#2	.		128	DS1#28	ALL	all DS1 circuits (default selection)	201	DS2#1	202	DS2#2	.		207	DS2#7	ALL	all DS2 circuits (default selection)	301	DS3#1	302	DS3 (Control Card A)	303	DS3 (Control Card B)	ALL	all DS3 circuits (default selection)	x	specific identifier (e.g. 1, 28, etc.)	ALL	all identifiers (default selection)
401	Generic																																												
402	Control Card A																																												
403	Control Card B																																												
404	Power Supply A																																												
405	Power Supply B																																												
ALL	all EQPT identifiers (default selection)																																												
101	DS1#1																																												
102	DS1#2																																												
.																																													
128	DS1#28																																												
ALL	all DS1 circuits (default selection)																																												
201	DS2#1																																												
202	DS2#2																																												
.																																													
207	DS2#7																																												
ALL	all DS2 circuits (default selection)																																												
301	DS3#1																																												
302	DS3 (Control Card A)																																												
303	DS3 (Control Card B)																																												
ALL	all DS3 circuits (default selection)																																												
x	specific identifier (e.g. 1, 28, etc.)																																												
ALL	all identifiers (default selection)																																												
CTAG*	Transaction Number (integer)																																												

**Table 9-2. TL1 Commands (Continued)**

<b>RTRV-COND-{EQPT rr ALL}:&lt;tid&gt;::&lt;ctag&gt;;</b>																																													
Description	Retrieves the requested alarms and conditions																																												
MOD2	Specifies what entity type to query: <ul style="list-style-type: none"> <li>• EQPT    General Equipment Unit</li> <li>• rr       Facility or Circuit (i.e. T1, VT1, STS1)</li> <li>• ALL     All entity types</li> </ul>																																												
TID	Target ID																																												
AID*	Identifies the component to which the desired alarm pertains. Identifiers are integers and are dependent on the entity specified in "MOD2" as follows: for EQPT: <table style="margin-left: 40px; border: none;"> <tr><td>401</td><td>Generic</td></tr> <tr><td>402</td><td>Control Card A</td></tr> <tr><td>403</td><td>Control Card B</td></tr> <tr><td>404</td><td>Power Supply A</td></tr> <tr><td>405</td><td>Power Supply B</td></tr> <tr><td>ALL</td><td>all EQPT identifiers (default selection)</td></tr> </table> for T1: <table style="margin-left: 40px; border: none;"> <tr><td>101</td><td>DS1#1</td></tr> <tr><td>102</td><td>DS1#2</td></tr> <tr><td>.</td><td></td></tr> <tr><td>128</td><td>DS1#28</td></tr> <tr><td>ALL</td><td>all DS1 circuits (default selection)</td></tr> </table> for T2: <table style="margin-left: 40px; border: none;"> <tr><td>201</td><td>DS2#1</td></tr> <tr><td>202</td><td>DS2#2</td></tr> <tr><td>.</td><td></td></tr> <tr><td>207</td><td>DS2#7</td></tr> <tr><td>ALL</td><td>all DS2 circuits (default selection)</td></tr> </table> for T3: <table style="margin-left: 40px; border: none;"> <tr><td>301</td><td>DS3#1</td></tr> <tr><td>302</td><td>DS3 (Control Card A)</td></tr> <tr><td>303</td><td>DS3 (Control Card B)</td></tr> <tr><td>ALL</td><td>all DS3 circuits (default selection)</td></tr> </table> for ALL: <table style="margin-left: 40px; border: none;"> <tr><td>x</td><td>specific identifier (e.g. 1, 28, etc.)</td></tr> <tr><td>ALL</td><td>all identifiers (default selection)</td></tr> </table>	401	Generic	402	Control Card A	403	Control Card B	404	Power Supply A	405	Power Supply B	ALL	all EQPT identifiers (default selection)	101	DS1#1	102	DS1#2	.		128	DS1#28	ALL	all DS1 circuits (default selection)	201	DS2#1	202	DS2#2	.		207	DS2#7	ALL	all DS2 circuits (default selection)	301	DS3#1	302	DS3 (Control Card A)	303	DS3 (Control Card B)	ALL	all DS3 circuits (default selection)	x	specific identifier (e.g. 1, 28, etc.)	ALL	all identifiers (default selection)
401	Generic																																												
402	Control Card A																																												
403	Control Card B																																												
404	Power Supply A																																												
405	Power Supply B																																												
ALL	all EQPT identifiers (default selection)																																												
101	DS1#1																																												
102	DS1#2																																												
.																																													
128	DS1#28																																												
ALL	all DS1 circuits (default selection)																																												
201	DS2#1																																												
202	DS2#2																																												
.																																													
207	DS2#7																																												
ALL	all DS2 circuits (default selection)																																												
301	DS3#1																																												
302	DS3 (Control Card A)																																												
303	DS3 (Control Card B)																																												
ALL	all DS3 circuits (default selection)																																												
x	specific identifier (e.g. 1, 28, etc.)																																												
ALL	all identifiers (default selection)																																												
CTAG*	Transaction Number (integer)																																												

**Table 9-2. TL1 Commands (Continued)**

<b>SET-DAT:&lt;tid&gt;::&lt;ctag&gt;::&lt;YY-MM-DD&gt;,&lt;HH-MM-SS&gt;;</b>	
Description	Sets the date and time
PARAM1	Date in YY-MM-DD format
PARAM2	Time in HH-MM-SS format

\* An asterisk indicates optional command blocks.

## TL1 Autonomous Messages

Autonomous messages provide a mechanism for real time reporting of system events. Although most events reported are alarms, some events are only informational. The Verb, Mod1, and Mod2 parameters of the message indicate what type of event has occurred.

---

### NOTE

The default setting for Autonomous message reporting is OFF.

---

Follow these steps to enable Autonomous message reporting:

- If it has not already been done, initiate a TL1 session by following the setup procedures and using the ACT-USER command.
- Use the ALW-MSG command to enable autonomous messaging. This command is described in [Table 9-2](#) on page 9-6.

REPT-ALM indicates an alarm event. [Table 9-3](#) on page 9-12 lists possible autonomous messages for alarm events and includes recommended actions to take. REPT-EVT indicates an informational event. [Table 9-4](#) on page 9-16 lists possible autonomous messages for informational events

Table 9-3. MX2800 Alarm Events

	AID	Notification Code	Condition Type	Service Affecting	Location	Description	Recommended Action
<b>REPT ALM T1</b>	101-128	MN	ACTLPBK	SA	NEND	DS1 In-test	No action. (This alarm is normal during DS1 loopback tests).
	101-128	MJ	LOS	SA	NEND	Loss Of Signal	Check DS1 facility entering MX2800 for valid signal.
<b>REPT ALM T2</b>	201-207	MJ	OOF	SA	NEND	DS2 Out Of Frame	Check for DS3 alarms. If none, check settings at far-end M13 multiplexer.
	201-207	MJ	RAI	SA	FEND	DS2 Remote Alarm Indication	Check status Of DS2 at far-end M13 multiplexer.
<b>REPT ALM T3</b>	301	MN	TSA	SA	NEND	DS3 in-test	No action (This alarm is normal during DS3 loopback tests.)
	301	MN	EXT-DS3	SA	FEND	FEND DS3 Equipment failure SA	Examine far-end M13 multiplexer to determine the reason it has signaled this condition.
	301	MN	LOS	SA	FEND	FEND DS3 Loss of Signal	Check DS3 facility entering the far-end M13 multiplexer.
	301	MN	OOF	SA	FEND	FEND DS3 Out of Frame	Check DS3 facility entering the far-end M13 multiplexer (including checking the provisioned DS3 framing type).
	301	MN	AIS	SA	FEND	FEND DS3 Alarm Indication Signal	Check status of DS3 at far-end M13 multiplexer.
	301	MN	ISD	SA	FEND	FEND DS3 Idle	Check for DS3 idle signal at far-end M13 multiplexer.
	301	MN	EXT-DS3	NSA	FEND	FEND DS3 Equipment Failure NSA	Examine far-end M13 multiplexer to determine the reason it has signaled this condition.
	301	MN	EXT	NSA	FEND	FEND Common Equipment Failure	Examine far-end M13 multiplexer to determine the reason it has signaled this condition.
	301	MN	LOS-M	SA	FEND	FEND Multiple DS1 Loss of Signal	Check for loss of signal at DS1 ports on far-end M13 multiplexer.
	301	MN	EXT-DS1	SA	FEND	FEND DS1 Equipment Failure SA	Examine far-end M13 multiplexer to determine the reason it has signaled this condition.
	301	MN	LOS-S	SA	FEND	FEND Single DS1 Loss of Signal	Check for loss of signal at DS1 ports on far-end M13 multiplexer.



**Table 9-3. MX2800 Alarm Events (Continued)**

	<b>AID</b>	<b>Notification Code</b>	<b>Condition Type</b>	<b>Service Affecting</b>	<b>Location</b>	<b>Description</b>	<b>Recommended Action</b>
<b>REPT ALM T3</b>	301	MN	EXT-DS1	NSA	FEND	FEND DS1 Equipment Failure NSA	Examine far-end M13 multiplexer to determine the reason it has signaled this condition.
	302 (CTRL A)	CR	LOS	SA	NEND	DS3 Loss Of Signal	Check DS3 facility entering the MX2800 for a valid signal.
	303 (CTRL B)						
	302 (CTRL A)	CR	OOF	SA	NEND	DS3 Out Of Frame	Check The provisioning of the DS3 framing type (M13 OR C-Bit) to make sure it matches the facility. If this is correct, check the DS3 facility entering the MX2800 for valid DS3 framing.
	303 (CTRL B)						
	302 (CTRL A)	MJ	RAI	SA	FEND	DS3 Remote Alarm Indication	Check the DS3 facility entering the far-end M13 multiplexer for AIS or severely-errored frames.
	303 (CTRL B)						
	302 (CTRL A)	MN	ISD	SA	FEND	DS3 idle	Check the far-end M13 multiplexer and any intermediate devices for reasons why they might be sending DS3 idle toward the MX2800.
303 (CTRL B)							

**Table 9-3. MX2800 Alarm Events (Continued)**

	<b>AID</b>	<b>Notification Code</b>	<b>Condition Type</b>	<b>Service Affecting</b>	<b>Location</b>	<b>Description</b>	<b>Recommended Action</b>
<b>REPT ALM EQPT</b>	401 (GENERAL)	MN	CTNEQPT	NSA	NEND	Controller Communication Failure	Check the standby card for proper LED behavior (and replace if necessary). If no problem is found, call ADTRAN Technical Support for further troubleshooting details.
	402 (CTRL A)	MN	CTNEQPT	NSA	NEND	Controller Card Failure	Replace the card which reports failure (should be indicated by a flashing red ACT LED and the AID of the alarm).
	403 (CTRL B)						
	402 (CTRL A)	CR	TRMT	SA	NEND	Ds3 Transmit Loss Of Signal	Replace the card for which TLOS is reported. Use the aid of the alarm to identify the card.
	403 (CTRL B)						
	402 (CTRL A)	MN	PROTNA	NSA	NEND	Controller Card Removed	Check to see if card was removed or reset by on-site personnel.
	403 (CTRL B)						
	404 (PS A)	MN	PWR	NSA	NEND	Power Supply Failure	Replace the failed power supply. Use the aid of the alarm to identify the card.
	405 (PS B)						
	404 (PS A)	MN	MISC	NSA	NEND	Power Supply Communication Failure	Replace the failed power supply. Use the aid of the alarm to identify the card.
405 (PS B)							

**Table 9-3. MX2800 Alarm Events (Continued)**

	<b>AID</b>	<b>Notification Code</b>	<b>Condition Type</b>	<b>Service Affecting</b>	<b>Location</b>	<b>Description</b>	<b>Recommended Action</b>
<b>REPT ALM EQPT</b>	404 (PS A)	MN	PWR-5	NSA	NEND	Power Supply Low	Replace the failed power supply. Use the aid of the alarm to identify the card.
	405 (PS B)						
	404 (PS A)	MN	HITEMP	NSA	NEND	Power Supply Temp High	Reduce the temperature of the MX2800's operating environment or provide better ventilation.
	405 (PS B)						
	404 (PS A)	MJ	HITEMP	NSA	NEND	Power Supply Temp Critical	Reduce the temperature of the MX2800's operating environment or provide better ventilation.
	405 (PS B)						
	404 (PS A)	MN	PWR-48	NSA	NEND	Power Supply Source Failure	Check the -48 volt input indicated by the AID for a blown fuse or disconnected/incorrect wiring.
	405 (PS B)						
	404 (PS A)	MN	PROTNA	NSA	NEND	Power Supply Card Removed	Check to see if card was removed by on-site personnel.
405 (PS B)							

Table 9-4. MX2800 Informational Events

	AID	Notification Code	Condition Type	Service Affecting	Location	Description	Recommended Action
<b>REPT EVT T1</b>	101-128	EVT	BPV	NSA	NEND	Excessive DS1 Bipolar Violation	Make sure the line coding (B8ZS/AMI) is provisioned correctly for this DS1 facility. Check the DS1 facility entering the MX2800 for impairments which may cause line code violations.
	101-128	EVT	AIS	NSA	FEND	DS1 Line AIS (LAIS)	Check the status of this DS1 signal toward the MX2800 at each DS1 device (for example, an intermediate device which sees LOS on the DS1 toward the MX2800 may transmit AIS toward the MX2800 in response).
	101-128	EVT	AISUONES	NSA	FEND	DS1 Carrier AIS (CAIS)	If there are no DS3 or DS2 alarms reported, check the status of the DS1 facility entering the far-end M13 multiplexer. For example, if the far end M13 multiplexer detects LOS on the DS1 facility, it will send DS1 AIS over the DS3 toward the MX2800.
<b>REPT EVT T2 REPT EVT T3</b>	201-207	EVT	AIS	NSA	FEND	DS2 AIS	Check status of DS2 at the far-end M13 multiplexer.
	302 (CTRL A)	EVT	AIS	NSA	FEND	DS3 Alarm Indication Signal	Check the status of the DS3 signal toward the MX2800 at each DS3 device. (For example, an intermediate device which sees LOS or LOF on the DS3 toward the MX2800 may transmit AIS toward the MX2800 in response.)
	303 (CTRL B)						
	302 (CTRL A)	EVT	BPV	NSA	NEND	Excessive DS3 Bipolar Violation	Check DS3 facility entering the MX2800 for problems which may produce bipolar violations.
	303 (CTRL B)						
<b>REPT EVT EQPT</b>	401 (GENERAL)	EVT	WKSWPR	NSA	NEND	Protection Switch	If protection switch was not performed manually, check for other alarms indicating the failure which caused the switch.
	401 (GENERAL)	EVT	ESW	NSA	NEND	Excessive Protection Switch	If protection switches were not performed manually, check for other alarms indicating the failure(s) which caused the switches.
<b>REPT EVT EQPT</b>	402 CTRL A	EVT	PROGFLT	NSA	NEND	Software Version Mismatch	Reset the reported card so the new software can take effect.
	403 CTRL B						

## 5. TL1 ERROR CODES

When the MX2800 denies a received TL1 command, the Output Response message has an associated four letter error code indicating the reason for denial. [Table 9-5](#) lists possible error codes.

**Table 9-5. TL1 Error Codes**

Error Code	Description
ICNV	Input, Command Not Valid
IDRG	Input, Date Range
IAC	Input, Invalid Access Identifier
IITA	Input, Invalid Target Identifier
IPNV	Input, Parameter Not Valid
PIUI	Privilege, Input User Not Valid
PLNA	Privilege, Login Not Active or Insufficient Privileges
SROF	Status, Requested Operation Failed
SSRE	Status, System Resources Exceeded

## TL1 Editing

TL1 editing commands allow the MX2800 to be provisioned through a TL1 session rather than through the menu system that is accessed using a VT100 terminal emulator. User account information must be provisioned through a console menu session or TL1 session prior to initiating a TL1 session. Once a TL1 session has been initiated using the ACT-USER command, see [Table 9-2](#) on page 9-6, the TL1 editing commands may be used. The standard format for an edit command is as follows:

```
ED-rr:<tid>:<aid>:<ctag>:::<keyword>=<value>;
```

The parameter descriptions are as follows:

- rr is T1, T2, T3, or EQPT
- <tid> is the Target Identifier
- <aid> is the Access Identifier
- <ctag> is a 1-to-6 character correlation tag (echoed in response)
- <keyword> is one of the entries from the data dictionaries in [Table 9-6](#) on page 9-20, [Table 9-7](#) on page 9-23, [Table 9-8](#) on page 9-24, or [Table 9-9](#) on page 9-27.
- <value> is one of the enumerated types in the data dictionaries, an integer, or Y/N, depending on the TYPE.

---

**NOTE**

<aid> and <ctag> are optional parameter. The placemaker : must remain in place. The default <aid> is All and the default <ctag> is 1.

---

**TL1 Editing Examples:**

ED-T1:UNIT-1:106:1::LBO=133TO266; (This would edit line build out for T1 #6 to be 133 to 266.)

ED-T2:UNIT-1:205:2::DS2CFGMODE=T1; (This would configure T2 #5 for T1 mode versus E1.)

ED-T3:UNIT-1:300:3::DS3MAXNUMSW=3; (This would set maximum number of switches for controller cards to 3.)

ED-EQPT:UNIT-1:400:4::PSTEMPCRITRLY=Y; (This would enable the alarm relay for power supply temperature critical.)

To view the value of a parameter, a retrieve (RTRV) command is used. The standard format for the RTRV command is as follows:

**RTRV-rr:<tid>:<aid>:<ctag>:::<keyword>;**

The parameter descriptions are as follows:

- rr is T1, T2, T3, or EQPT
- <tid> is the Target Identifier
- <aid> is the Access Identifier
- <ctag> is a 1 to 6 character correlation tag (echoed in response)
- <keyword> is one of the entries from the following data dictionaries in [Table 9-6](#) on page 9-20, [Table 9-7](#) on page 9-23, [Table 9-8](#) on page 9-24, or [Table 9-9](#) on page 9-27.

---

**NOTE**

<aid> and <ctag> are optional parameter. The placemaker : must remain in place. The default <aid> is All and the default <ctag> is 1.

---

TL1 RTRV examples:

RTRV-R1::109:4; (This would return the values for all parameters related to T1 #9.)

---

**NOTE**

If no parameter is specified, all valid parameters to the <aid> are retrieved.

---

RTRV-T1:UNIT-1:106:1::LBO; (This would return the value of line build out for T1 #6.)

RTRV-T2:UNIT-1:205:2::DS2CFGMODE; (This would return the configuration mode of T2 #5.)

RTRV-T3:UNIT-1:300:3:::DS3MAXNUMSW; (This would return the setting for the maximum number of switches for controller cards.)

RTRV-EQPT:UNIT-1:400:5:::PSTEMPCRITRLY; (This would return the status of the alarm relay for power supply temperature critical.)

## Data Dictionaries

The data dictionaries that follow are to be used while performing TL1 editing or retrieve commands. Each data dictionary contains four columns. The columns are as follows:

- Keyword gives the values to be placed in the <keyword> portion of the edit command.
- Type describes the type of <value> that is required to be entered in the edit command.
  - ENUM requires a text and/or number string to be entered as the <value>.
  - Y/N requires a Y or N representing yes or no to be entered as the <value>.
  - INT requires that an integer be entered as the <value>.
- Domain describes valid entries that may be entered into the <value> portion of the edit command.
- Description explains each of the edit or retrieve commands.

**Table 9-6** contains entries that are used to edit or retrieve options for the DS3 portion of the MX2800. When performing TL1 edit commands from this table, the value of rr should be T3, and the <aid> value should be one of the following:

- 300 for all DS3 Circuits
- 301 for DS3 #1
- 302 for DS3 Control Card A
- 303 for DS3 Control Card B

**Table 9-6. TL1 Editing Data Dictionary for DS3**

Keyword	Type	Domain	Description
ACTIVECONTROLLER	ENUM	One of the following: <ul style="list-style-type: none"> <li>• A</li> <li>• B</li> </ul>	Selects which controller card is active <ul style="list-style-type: none"> <li>• controller card A is active</li> <li>• controller card B is active</li> </ul>
CARDSWRLY	Y/N	Y or [N]	Identifies status of System Protection Switch alarm relay <ul style="list-style-type: none"> <li>• Yes (Y) - enables alarm</li> <li>• No (N) - disables alarm</li> </ul>
DIAGDS3	ENUM	One of the following: <ul style="list-style-type: none"> <li>• DATAMODE</li> <li>• LINELPBK</li> <li>• DIGLPBK</li> <li>• METLPBK</li> <li>• REMLPBK</li> <li>• ALLT1</li> </ul>	Enables the selected DS3 loopback <ul style="list-style-type: none"> <li>• Refer to <i>Data Mode</i> on page 6-2</li> <li>• Refer to <i>Line Loopback</i> on page 6-7</li> <li>• Refer to <i>Digital Loopback</i> on page 6-7</li> <li>• Refer to <i>Metallic Loopback</i> on page 6-8</li> <li>• Refer to <i>Remote Loopback</i> on page 6-8</li> <li>• Refer to <i>Remote All T1/E1</i> on page 6-8</li> </ul>
DS3AISRLY	Y/N	Y or [N]	Identifies status of DS3 AIS alarm relay <ul style="list-style-type: none"> <li>• Yes (Y) - enables alarm</li> <li>• No (N) - disables alarm</li> </ul>



**Table 9-6. TL1 Editing Data Dictionary for DS3 (Continued)**

<b>Keyword</b>	<b>Type</b>	<b>Domain</b>	<b>Description</b>
DS3CVTHRS	ENUM	One of the following: <ul style="list-style-type: none"> <li>• Disable</li> <li>• 1E3</li> <li>• 1E4</li> <li>• 1E5</li> <li>• 1E6</li> </ul>	Indicates a limit on the number of code violations accepted by the unit over the DS3 before the unit switches controller cards <ul style="list-style-type: none"> <li>• 1E3 - 1 out of every 1,000 bits contains a CV</li> <li>• 1E4 - 1 out of every 10,000 bits contains a CV</li> <li>• 1E5 - 1 out of every 100,000 bits contains a CV</li> <li>• 1E6 - 1 out of every 1,000,000 bits contains a CV</li> </ul>
DS3LOFRLY	Y/N	Y or [N]	Identifies status of DS3 LOF alarm relay <ul style="list-style-type: none"> <li>• Yes (Y) - enables alarm</li> <li>• No (N) - disables alarm</li> </ul>
DS3LOSRLY	Y/N	Y or [N]	Identifies status of DS3 LOS alarm relay <ul style="list-style-type: none"> <li>• Yes (Y) - enables alarm</li> <li>• No (N) - disables alarm</li> </ul>
DS3MAXNUMSW	INT	0, 1, 2, ..., N	Maximum number of times per hour the unit is allowed to switch between controller cards. If number is exceeded, the unit will issue a trap
DS3MINSWPERIOD	INT	0, 1, 2, ..., N	Number of seconds that must pass after a protection switch before another protection switch will be allowed
DS3PROT	Y/N	Y or [N]	Identifies status of DS3 protection switching <ul style="list-style-type: none"> <li>• Yes (Y) - enables DS3 protection switching</li> <li>• No (N) - disables DS3 protection switching</li> </ul>
DS3RAIRLY	Y/N	Y or [N]	Identifies status of DS3 RAI alarm relay <ul style="list-style-type: none"> <li>• Yes (Y) - enables alarm</li> <li>• No (N) - disables alarm</li> </ul>
DS3TLOSRLY	Y/N	Y or [N]	Identifies status of DS3 TLOS alarm relay Yes (Y) - enables alarm No (N) - disables alarm
DS3XCVRLY	Y/N	Y or [N]	Identifies status of DS3 XCV alarm relay <ul style="list-style-type: none"> <li>• Yes (Y) - enables alarm</li> <li>• No (N) - disables alarm</li> </ul>

**Table 9-6. TL1 Editing Data Dictionary for DS3 (Continued)**

<b>Keyword</b>	<b>Type</b>	<b>Domain</b>	<b>Description</b>
FMT	ENUM	One of the following: <ul style="list-style-type: none"> <li>• CBIT</li> <li>• M13</li> </ul>	Sets framing format to match the format of the receive signal at the network interface <ul style="list-style-type: none"> <li>• The framing format is set to CBIT</li> <li>• The framing format is set to M13</li> </ul>
LINELEN	ENUM	One of the following: <ul style="list-style-type: none"> <li>• LONG</li> <li>• SHORT</li> </ul>	Identifies Network DS3 line length <ul style="list-style-type: none"> <li>• LONG - exceeds 50 feet.</li> <li>• SHORT - less than 50 feet.</li> </ul>
RMTLPBK	ENUM	One of the following: <ul style="list-style-type: none"> <li>• DISABLE</li> <li>• EITHER</li> <li>• FEAC</li> <li>• CBIT</li> </ul>	Indicates whether the unit will respond to remote loopbacks over FEAC, CBIT, EITHER, or if remote loopbacks are disabled <ul style="list-style-type: none"> <li>• DISABLE - do not respond</li> <li>• EITHER - respond over either FEAC or CBIT</li> <li>• FEAC - respond over FEAC</li> <li>• CBIT - respond over CBIT</li> </ul>
SYSCARDARLY	Y/N	Y or [N]	Identifies status of System Controller Card A alarm relay <ul style="list-style-type: none"> <li>• Yes (Y) - enables alarm</li> <li>• No (N) - disables alarm</li> </ul>
SYSCARDBRLY	Y/N	Y or [N]	Identifies status of System Controller Card B alarm relay <ul style="list-style-type: none"> <li>• Yes (Y) - enables alarm</li> <li>• No (N) - disables alarm</li> </ul>
SYSCARDCOMMRLY	Y/N	Y or [N]	Identifies status of System Communication Fail alarm relay <ul style="list-style-type: none"> <li>• Yes (Y) - enables alarm</li> <li>• No (N) - disables alarm</li> </ul>
SYSCARDRLY	Y/N	Y or [N]	Identifies status of System Controller Card alarm relay <ul style="list-style-type: none"> <li>• Yes (Y) - enables alarm</li> <li>• No (N) - disables alarm</li> </ul>
TMG	ENUM	One of the following: <ul style="list-style-type: none"> <li>• LPD</li> <li>• INT</li> </ul>	Identifies timing supply for the DS3 <ul style="list-style-type: none"> <li>• LPD - loop timed</li> <li>• INT - internal timing source</li> </ul>

**Table 9-7** contains entries that are used to edit or retrieve options for the DS2 portion of the MX2800. When performing TL1 edit commands from this table, the value of rr should be T2 and the <aid> value should be one of the following:

201 - DS2#1  
 202 - DS2#2  
 .  
 .  
 .  
 207 - DS2#7

**Table 9-7. TL1 Editing Data Dictionary for DS2**

Keyword	Type	Domain	Description
DIAGDS2TESTSTATE	ENUM	One of the following: <ul style="list-style-type: none"> <li>• DATAMODE</li> <li>• NETWORK</li> </ul>	Identifies DS2 Diagnostic Loopback <ul style="list-style-type: none"> <li>• NETWORK selects the available loopback</li> <li>• DATAMODE ends a test in progress</li> </ul>
DS2AISRLY	Y/N	Y or [N]	Identifies status of DS2 AIS alarm relay <ul style="list-style-type: none"> <li>• Yes (Y) - enables alarm</li> <li>• No (N) - disables alarm</li> </ul>
DS2CFGMODE	ENUM	One of the following: <ul style="list-style-type: none"> <li>• T1</li> <li>• E1</li> </ul>	Identifies DS2 Configuration <ul style="list-style-type: none"> <li>• T1 sets DS2 configuration to M12 (4xT1).</li> <li>• E1 sets DS2 configuration to G.747 (3xE1).</li> </ul>
DS2LOSRLY	Y/N	Y or [N]	Identifies status of DS2 LOS alarm relay <ul style="list-style-type: none"> <li>• Yes (Y) - enables alarm</li> <li>• No (N) - disables alarm</li> </ul>
DS2RAIRLY	Y/N	Y or [N]	Identifies status of DS2 RAI alarm relay <ul style="list-style-type: none"> <li>• Yes (Y) - enables alarm</li> <li>• No (N) - disables alarm</li> </ul>

**Table 9-8** contains entries that are used to edit or retrieve options for the DSX portion of the MX2800. When performing TL1 edit commands from this table, the value of rr should be T1, and the <aid> value should be one of the following:

101 - DS1#1  
 102 - DS1#2  
 .  
 .  
 .  
 128 - DS1#28

**Table 9-8. TL1 Editing Data Dictionary for DS1**

Keyword	Type	Domain	Description
DIAGDSXTESTSTATE	ENUM	One of the following: <ul style="list-style-type: none"> <li>• DATAMODE</li> <li>• TRIBUTARY</li> <li>• ANALOGNET</li> <li>• DIGNET</li> <li>• CODEC</li> <li>• REMLPBK</li> <li>• CSULPBK</li> <li>• CSUBERT</li> <li>• LINEBERT</li> </ul>	Identifies DSX Diagnostic Loopbacks. Choose an available loopback <ul style="list-style-type: none"> <li>• Refer to <i>Data Mode</i> on page 6-2</li> <li>• Refer to <i>Tributary</i> on page 6-2</li> <li>• Refer to <i>Analog Network</i> on page 6-3</li> <li>• Refer to <i>Digital Line/Net</i> on page 6-3</li> <li>• Refer to <i>Codec Line/Net</i> on page 6-4</li> <li>• Refer to <i>Remote Loopback</i> on page 6-4</li> <li>• Refer to <i>CSU Loopback</i> on page 6-4</li> <li>• Refer to <i>CSU Loopback w/BERT</i> on page 6-4</li> <li>• Refer to <i>Line BERT</i> on page 6-5</li> </ul>
DSXCAISRLY	Y/N	Y or [N]	Identifies status of DSX CAIS alarm relay. <ul style="list-style-type: none"> <li>• Yes (Y) - enables alarm</li> <li>• No (N) - disables alarm</li> </ul>
DSXCFGLINESWPROT	ENUM	One of the following: <ul style="list-style-type: none"> <li>• DISABLE</li> <li>• ENABLE</li> <li>• UNAVAIL</li> </ul>	Identifies the state of the DSX Switch Protection <ul style="list-style-type: none"> <li>• DISABLE - the switch is disabled</li> <li>• ENABLE - the switch is enabled</li> <li>• UNAVAIL - the switch is not in the configuration</li> </ul>

**Table 9-8. TL1 Editing Data Dictionary for DS1 (Continued)**

<b>Keyword</b>	<b>Type</b>	<b>Domain</b>	<b>Description</b>
DSXCFGSTATE	ENUM	One of the following: <ul style="list-style-type: none"> <li>• DISABLE</li> <li>• ENABLE</li> <li>• UNAVAIL</li> <li>• AUTO</li> </ul>	Identifies the DSX configuration state <ul style="list-style-type: none"> <li>• DISABLE - disables the current configuration</li> <li>• ENABLE - enable the newest configuration</li> <li>• UNAVAIL - the configuration is unavailable</li> <li>• AUTO - the configuration is set to auto save in nonvolatile memory</li> </ul>
DSXCVTHRS	ENUM	One of the following: <ul style="list-style-type: none"> <li>• DISABLE</li> <li>• 1E3</li> <li>• 1E4</li> <li>• 1E5</li> <li>• 1E6</li> </ul>	Indicates a limit on the number of code violations accepted by the unit over a single T1/E1 before the unit switches controller cards <ul style="list-style-type: none"> <li>• 1E3 - 1 out of every 1,000 bits on a single T1/E1 contains a CV</li> <li>• 1E4 - 1 out of every 10,000 bits on a single T1/E1 contains a CV</li> <li>• 1E5 - 1 out of every 100,000 bits on a single T1/E1 contains a CV</li> <li>• 1E6 - 1 out of every 1,000,000 bits on a single T1/E1 contains a CV</li> </ul>
DSXLAISRLY	Y/N	Y or [N]	Identifies status of DSX LAIS alarm relay <ul style="list-style-type: none"> <li>• Yes (Y) - enables alarm</li> <li>• No (N) - disables alarm</li> </ul>

**Table 9-8. TL1 Editing Data Dictionary for DS1 (Continued)**

<b>Keyword</b>	<b>Type</b>	<b>Domain</b>	<b>Description</b>
DSXLBKDETECTION	ENUM	One of the following: <ul style="list-style-type: none"> <li>• DISABLE</li> <li>• CSU</li> <li>• NIU</li> <li>• M13INBAND</li> <li>• UNAVAIL</li> </ul>	Identifies for each T1/E1 interface whether the T1/E1 will respond to loopback requests <ul style="list-style-type: none"> <li>• DISABLE - does not respond to loopback tests</li> <li>• CSU - cause the channel to loop up or loop down when it receives a CSU loop-up or loop-down pattern for more than 5 seconds</li> <li>• NIU - cause the channel to loop up or loop down when it receives an NIU loop-up or loop-down pattern for more than 5 seconds</li> <li>• M13INBAND - cause the channel to loop up or loop down when it receives an M13INBAND loop-up or loop-down pattern for more than 5 seconds</li> <li>• UNAVAIL - T1/E1 not available for loopback tests</li> </ul>
DSXLOSRLY	Y/N	Y or [N]	Identifies status of DSX LOS alarm relay <ul style="list-style-type: none"> <li>• Yes (Y) - enables alarm</li> <li>• No (N) - disables alarm</li> </ul>
DSXPROTTHRS	INT	1-28	Number of Enabled lines that must fail before a protection switch occurs
DSXXCVRLY	Y/N	Y or [N]	Identifies status of DSX XCV alarm relay <ul style="list-style-type: none"> <li>• Yes (Y) - enables alarm</li> <li>• No (N) - disables alarm</li> </ul>
LBO	ENUM	One of the following: <ul style="list-style-type: none"> <li>• 0TO133</li> <li>• 133TO266</li> <li>• 266TO399</li> <li>• 399TO533</li> <li>• 533TO655</li> <li>• MINUS7R5</li> <li>• E10TO3000</li> <li>• UNAVAIL</li> </ul>	Identifies the line length for each T1 interface according to the distance from the MX2800 to the DTE device <ul style="list-style-type: none"> <li>• 0TO133, 133TO266, 266TO399, 399TO533, 533TO655 - distance in feet</li> <li>• MINUS7R5 - -7.5dB length</li> <li>• E10TO3000 - setting for E1</li> <li>• UNAVAIL - unavailable</li> </ul>

**Table 9-8. TL1 Editing Data Dictionary for DS1 (Continued)**

Keyword	Type	Domain	Description
LINECDE	ENUM	One of the following: <ul style="list-style-type: none"> <li>• AMI</li> <li>• B8ZS</li> <li>• E1AMI</li> <li>• E1HDB3</li> <li>• UNAVAIL</li> </ul>	Identifies line code for T1/E1s to match connected devices <ul style="list-style-type: none"> <li>• AMI - set T1 to AMI</li> <li>• B8ZS - Sets T1 to B8ZS</li> <li>• E1AMI - sets E1 to AMI</li> <li>• E1HDB3 - sets E1 to HDB3</li> <li>• UNAVAIL - no T1/E1 available</li> </ul>

**Table 9-9** contains entries that are used to edit or retrieve options for the equipment portion of the MX2800. When performing TL1 edit commands from this table, the value of rr should be EQPT, and the <aid> value should be one of the following:

- 400 - All EQPT identifiers
- 401 - Generic
- 402 - Control Card A
- 403 - Control Card B
- 404 - Power Supply A
- 405 - Power Supply B

**Table 9-9. TL1 Editing Data Dictionary for EQPT**

Keyword	Type	Domain	Description
DIAGBERCLEARCOUNT	Y/N	Y or [N]	Clears BERT count <ul style="list-style-type: none"> <li>• Yes (Y) - clears the BERT count</li> <li>• No (N) - does not clear the BERT count</li> </ul>
DIAGBERTCOUNT	INT	0, 1, 2, ..., N	Error count
DIAGBERTSYNC	ENUM	One of the following: <ul style="list-style-type: none"> <li>• NOSYNC</li> <li>• SYNC</li> </ul>	Identifies state of Pattern Synchronization <ul style="list-style-type: none"> <li>• NOSYNC - there is no pattern sync</li> <li>• SYNC - pattern sync is available</li> </ul>

**Table 9-9. TL1 Editing Data Dictionary for EQPT (Continued)**

<b>Keyword</b>	<b>Type</b>	<b>Domain</b>	<b>Description</b>
DIAGLPBKTIMEOUT	ENUM	One of the following: <ul style="list-style-type: none"> <li>• DISABLE</li> <li>• 1-MIN</li> <li>• 5-MINL</li> <li>• 10-MIN</li> <li>• 15-MIN</li> <li>• 30-MIN</li> <li>• 45-MIN</li> <li>• 1-HR</li> <li>• 2-HR</li> </ul>	Identifies the amount of time before a Diagnostic Loopback will time out <ul style="list-style-type: none"> <li>• DISABLE - timeout is disabled</li> <li>• 1-MIN - timeout value is one minute</li> <li>• 5-MINL - timeout value is five minutes</li> <li>• 10-MIN - timeout value is ten minutes</li> <li>• 15-MIN - timeout value is 15 minutes</li> <li>• 30-MIN - timeout value is 30 minutes</li> <li>• 45-MIN - timeout value is 45 minutes</li> <li>• 1-HR - timeout value is 60 minutes</li> <li>• 2-HR - timeout value is 120 minutes</li> </ul>
DIAGRESET	Y/N	Y or [N]	Resets Diagnostic Loopbacks <ul style="list-style-type: none"> <li>• Yes (Y) - reset the diagnostic loopback</li> <li>• No (N) - do not reset the diagnostic loopback</li> </ul>
PSBATTERYLOWRLY	Y/N	Y or [N]	Identifies status of Power Supply Battery Low alarm relay <ul style="list-style-type: none"> <li>• Yes (Y) - enables alarm</li> <li>• No (N) - disables alarm</li> </ul>
PSCHARGERFAILRLY	Y/N	Y or [N]	Identifies status of Power Supply Charger Fail alarm relay <ul style="list-style-type: none"> <li>• Yes (Y) - enables alarm</li> <li>• No (N) - disables alarm</li> </ul>
PSFANFAILRLY	Y/N	Y or [N]	Identifies status of Power Supply Fan Fail alarm relay <ul style="list-style-type: none"> <li>• Yes (Y) - enables alarm</li> <li>• No (N) - disables alarm</li> </ul>
PSMALFNCRLY	Y/N	Y or [N]	Identifies status of Power Supply Malfunction alarm relay <ul style="list-style-type: none"> <li>• Yes (Y) - enables alarm</li> <li>• No (N) - disables alarm</li> </ul>
PSPOWERFAILRLY	Y/N	Y or [N]	Identifies status of Power Supply Power Fail alarm relay <ul style="list-style-type: none"> <li>• Yes (Y) - enables alarm</li> <li>• No (N) - disables alarm</li> </ul>



**Table 9-9. TL1 Editing Data Dictionary for EQPT (Continued)**

<b>Keyword</b>	<b>Type</b>	<b>Domain</b>	<b>Description</b>
PSPowerLowRly	Y/N	Y or [N]	Identifies status of Power Supply Power Low alarm relay <ul style="list-style-type: none"> <li>• Yes (Y) - enables alarm</li> <li>• No (N) - disables alarm</li> </ul>
PSTempCritRly	Y/N	Y or [N]	Identifies status of Power Supply Temperature Critical alarm relay <ul style="list-style-type: none"> <li>• Yes (Y) - enables alarm</li> <li>• No (N) - disables alarm</li> </ul>
PSTempHighRly	Y/N	Y or [N]	Identifies status of Power Supply Temperature High alarm relay <ul style="list-style-type: none"> <li>• Yes (Y) - enables alarm</li> <li>• No (N) - disables alarm</li> </ul>

## TL1 Loopback Commands

The OPR-LPBK and RLS-LPBK commands are provided as an alternative to ED commands to perform loopbacks through TL1. The general format for these commands is as follows:

```
OPR-LPBK- {T1 | T2 | T3} : <tid> : <aid> : <ctag> : : <locn> , , , <lpbktype> ;
```

```
RLS-LPBK- {T1 | T2 | T3} : <tid> : <aid> : <ctag> : : <locn> , , , <lpbktype> ;
```

**Table 9-10** describes each of the DS3 loopbacks that can be initiated or released with these commands.

**Table 9-10. DS3 TL1 Loopback Commands**

Verb	MOD2	<aid> <sup>1</sup>	<locn>	<lpbktype>	Description
OPR	T3	3xy	NEND	LINE	Initiates the DS3 Line Loopback
RLS	T3	3xy	NEND	LINE	Releases the DS3 Line Loopback
OPR	T3	3xy	NEND	DIGLPBK	Initiates the DS3 Digital Loopback
RLS	T3	3xy	NEND	DIGLPBK	Releases the DS3 Digital Loopback
OPR	T3	3xy	NEND	TERMINAL	Initiates the DS3 Network Loopback
RLS	T3	3xy	NEND	TERMINAL	Releases the DS3 Network Loopback
OPR	T3	3xy	FEND	LINE	Initiates the DS3 Remote Loopback
RLS	T3	3xy	FEND	LINE	Releases the DS3 Remote Loopback
OPR	T3	3xy	FEND	ALLT1	Initiates the DS3 All T1/E1 Loopback
RLS	T3	3xy	FEND	ALLT1	Releases the DS3 All T1/E1 Loopback
RLS	T3	3xy			Releases any active DS3 Loopback

1. The value of xy may be 00 through 03.

**Table 9-11** describes each of the DS2 loopbacks that can be initiated or released with these commands.

**Table 9-11. DS2 TL1 Loopback Commands**

Verb	MOD2	<aid> <sup>*</sup>	<locn>	<lpbktype>	Description
OPR	T2	2xy	NEND	NETWORK	Initiates the DS2 Network Loopback
RLS	T2	2xy	NEND	NETWORK	Releases the DS2 Network Loopback
RLS	T2	2xy			Releases any active DS2 Loopback

\* The value of xy may be 01 through 07, corresponding to the desired DS2 channel.

**Table 9-12** describes each of the DS1 loopbacks that can be initiated or released with DS1 TL1 loopback commands.

**Table 9-12. DS1 TL1 Loopback Commands**

Verb	MOD2	<aid>*	<locn>	<lpbktype>	Description
OPR	T1	lxy	NEND	NETWORK	Initiates the DS1 Tributary Loopback
RLS	T1	lxy	NEND	NETWORK	Releases the DS1 Tributary Loopback
OPR	T1	lxy	NEND	TERMINAL	Initiates the DS1 Analog Loopback
RLS	T1	lxy	NEND	TERMINAL	Releases the DS1 Analog Loopback
OPR	T1	lxy	NEND	DIGNET	Initiates the DS1 Digital Line/Net Loopback
RLS	T1	lxy	NEND	DIGNET	Releases the DS1 Digital Line/Net Loopback
OPR	T1	lxy	NEND	CODEC	Initiates the DS1 Codec Line/Net Loopback
RLS	T1	lxy	NEND	CODEC	Releases the DS1 Codec Line/Net Loopback
OPR	T1	lxy	FEND	DS1FEAC	Initiates the DS1 Remote Loopback
RLS	T1	lxy	FEND	DS1FEAC	Releases the DS1 Remote Loopback
OPR	T1	lxy	FEND	CSULPBK	Initiates the DS1 CSU Loopback
RLS	T1	lxy	FEND	CSULPBK	Releases the DS1 CSU Loopback
OPR	T1	lxy	FEND	CSUBERT	Initiates the DS1 CSU Loopback w/BERT
RLS	T1	lxy	FEND	CSUBERT	Releases the DS1 CSU Loopback w/BERT
RLS					Releases any active DS1 Loopback

\* The value of xy may be 01 through 28, corresponding to the desired DS1 channel.



# Appendix A

## Acceptance Test Procedure

### 1. INTRODUCTION

This appendix describes the procedures to be used in performing acceptance testing of ADTRAN's Total Access MX2800 M13 Multiplexer. It is assumed that the MX2800 has already been installed, powered-up, equipped and cabled to the DSX-1 and DSX-3 or connecting equipment according to the specifications described in [Section 2, Installation and Operation](#) and local operating company procedures.

The MX2800 is an M13 multiplexer used to consolidate 28 DS1 circuits on to a DS3. The unit can be equipped in various ways. In general, this section addresses the following areas:

- Verifying the options installed on the unit
- Configuring the unit for test
- Testing all DS1 and DS3 circuits to make sure that each circuit passes error free data
- Verifying that alarms are generated and passed to external alarm systems
- Testing the system power supply and controller card redundancy
- Restoring the unit to the desired configuration
- Configuring the unit for customer traffic
- Completing the Acceptance Test Procedures (ATP) Checklist

### 2. VERIFYING THE INSTALLED OPTIONS

The installed configuration determines the level of redundancy the unit supports. There may be one or two Power Supply Units (PSUs) and Controller Card Units (CCUs) present. A single PSU and CCU are required for operation without redundancy. Equipping the shelf with two of each provides full redundancy. The PSUs are the smaller modules on the left side. The CCUs are the larger modules toward the center and right of the shelf. Visually note which cards are installed in the chassis under test.

If this card is installed...	Check
Power Supply A (far left slot) installed?	
Power Supply B (next slot to right) installed	
Controller A (lower controller card) installed	
Controller A (upper controller card) installed	

### 3. CONFIGURING THE SYSTEM

Before the required tests can be performed, a minimal amount of configuration must be performed on the MX2800. It is necessary to gain access to the Provisioning menus through the Craft Port, then set the desired parameters for the DS1 ports, the DS3 port, and the alarm attributes. The following paragraphs step through the process.

#### Accessing the Craft Port

The MX2800 is shipped with a flat silver-satin cable that plugs into the Craft jack on the front panel and a DB-9 adapter that allows the cable to plug into the **COM** port on a computer or dumb terminal. Make these connections, then start up a terminal emulation program on a computer (e.g., HyperTerminal, Procomm, Crosstalk, etc.), using VT100 emulation with a character format of 9600 baud, no parity, eight bits, and one stop bit. Press the ENTER key several times. A username prompt should appear. The default username is “username”. The default password is “password”. The input characters for username and password are not case sensitive. After the logon and password are accepted, the MX2800 Main Menu should appear. This is the screen from which all other management and control functions are accessible.

#### Provisioning the DS3 Port

In order for the MX2800 to correctly pass traffic through the system, the DS3 and DS1 ports need to be properly configured. The provisioning of the DS3 port is covered in this subsection, and the provisioning of the DS1 ports is covered in the next.

---

#### NOTE

The ENTER key is used to select a function, and the ESC key is used to back up a level in the menu system.

---

Follow these procedures to configure DS3 ports.

1. From the Main Menu, select Configuration, and then select Network Interface. The Network Configuration screen should appear. Set each of the options on this screen as referenced below.

---

**NOTE**

To change an option, simply enter the corresponding number, press ENTER, and follow the prompts.

---

**DS3 Configuration**

- Framing = C-Bit (default = M13)
- Line Length = Use 0-225 ft. (default) or 225-450 ft., depending on the distance to the DS3 Cross connect panel or connecting equipment.
- Timing = Local (default = Loop)

---

**NOTE**

When performing tests to a DS3 loopback, the timing must be set to Local to guarantee DS3 frame synchronization and error-free testing during bit error tests. Normal operation generally requires that this attribute be set back to Loop (system default) after all acceptance tests are completed. One exception to the rule is when connecting two MX2800s together on a back-to-back basis (DS3s facing one another). In that case, one MX2800 must be set to Local and the other to Loop.

---

- Remote Loopbacks = FEAC/C-Bit (default)
- XCV Threshold = Disabled (default)

**Protection Configuration**

- Active Controller = A (default)
- Network Protection = Disabled (default)
- Max Switch Threshold = 3 (default)
- Min. Switching Period (sec.) = 10 (default)

**Miscellaneous**

- Loopback Time Out = 5 min. (default)

**DS2 Configuration**

- DS2 #1 = M12(4xT1)
- DS2 #2 = M12(4xT1)
- DS2 #3 = M12(4xT1)
- DS2 #4 = M12(4xT1)
- DS2 #5 = M12(4xT1)

- DS2 #6 = M12(4xT1)
- DS2 #7 = M12(4xT1)

---

**NOTE**

For additional information about the previous configuration, refer to [Network Interface](#) on page 3-4.

---

2. Press the ESC key to get back to the main Configuration menu.

## Provisioning the DS1 Ports

1. From the main Configuration menu, select T1/E1 Interface. The Configure T1/E1 Interface menu should appear. Since there are 28 DS1 ports to configure and all of them need to be set identically during acceptance testing, the Set Multiple provisioning feature of the MX2800 is used during this step.  
To use the Set Multiple feature, select the attribute from the Configure T1/E1 Interface screen. From the Set Multiple screen, confirm that First = 1 and Last = 28. If not, make the necessary corrections. Select State to toggle the State as necessary until the correct setting is displayed, and select Apply settings to set all 28 DS1s to that mode. Press ESC twice to return to the Configure T1/E1 Interface menu.
2. Select T1/E1 State. If all channels are set to Auto Enable (default), press ESC to get back to the Configure T1/E1 Interface menu and proceed to the next step. If not, perform the Set Multiple routine referenced above.
3. Select T1/E1 Line Coding. If all channels are set to B8ZS (default), press ESC to get back to the Configure T1/E1 Interface menu and proceed to the next step. If not, perform the Set Multiple routine accordingly.
4. Select T1/E1 Line length. If all channels are set correctly (0-133, 133-266, 266-399, 399-533 or 533-655 feet) as appropriate for the installation, proceed to the next step. If not, perform the Set Multiple routine accordingly.
5. Select T1/E1 Loopback Detection.
6. Select Set Multiple. Set First to 1, Last to 28, Loopback Detection to Disabled. Select Apply Settings.
7. Press ESC twice to return to the Configure T1/E1 Interface menu.
8. Select T1/Circuit Protection.
9. Select Set Multiple. Set First to 1 and Last to 28. Set Circuit Protection to Enabled. Select Apply Settings.
10. Press ESC once and select Protection Threshold. Enter a value of 1 and press ESC once to return to the Configure T1/E1 Interface menu.
11. Select XCV Threshold. Select Disabled.
12. Press the Esc key to get back to the main Configuration menu.



---

## Alarm Relay Configuration

Although there are numerous alarm configuration options available on the MX2800, the ability to generate only one Critical and one Noncritical alarm are the only requirements for this part of the acceptance test process. These requirements confirms that the alarm contacts are wired and operating correctly and transmitting the appropriate alarm conditions back to the central office alarm panel.

1. From the main Configuration menu, select System Management.
2. Select Alarm Relay Configuration to get to the Alarm Relay Configuration screen.
3. As necessary, toggle the DS3 LOS state to Enabled, thus forcing generation of a Critical alarm when the DS3 port sees a Loss of Signal condition.
4. As necessary, toggle the LOS state to Enabled, thus forcing generation of a Noncritical alarm when a DS1 port sees a Loss of Signal condition.
5. Toggle the SAVE CONFIG state.

## 4. VERIFYING THE DATA INTEGRITY

Now that the system has been properly provisioned for acceptance testing, proceed with the testing of the system. The first key test is to verify that the MX2800 can pass traffic between the DS1 and DS3 ports. Three different methods of testing are presented. One of the three should be selected based on test equipment availability and network configuration. All of the tests are performed at the DSX-1 and DSX-3 cross-connect bays or connecting equipment so that both the MX2800 circuitry and the office cabling are tested. If problems are encountered during testing, refer to [Section 4, Status](#) and [Section 5, Statistics](#) for assistance with problem determination.

### DS1 Daisy-Chain to DS3 (Hard) Loopback

This test can be performed single-handedly, and it can be used only if DS1s are terminated at the DSX1. It loads all 28 ports of the MX2800 with traffic at the same time, but it does *not* confirm DS3 cabling integrity (transmit Vs. receive).

Equipment Required:

- 1 DS1 test set for running a BERT
- 28 DS1 bantam test cords
- 1 DS3 test cord

Follow these procedures to test the daisy-chain.

1. At the DSX-3 cross-connect panel or connecting equipment, loop the DS3 from the MX2800 back on itself. Confirm that the MX2800 sees a good DS3 signal. The **DS3 STATUS** LED should be solid green on the Active Controller, and the DS3 test set should be in frame synchronization with the MX2800.
2. At the DSX-1 cross-connect panel, insert the **Transmit** output of the DS1 test set into the **Input** of the first DS1 channel of the MX2800.

3. At the DSX-1, install a bantam test cord from the **Output** of the first DS1 channel to the **Input** of the second; then connect a second bantam test cord from the **Output** of the second DS1 channel to the **Input** of the third DS1 channel. Repeat this procedure for all 28 DS1 channels.
4. Connect the **Output** of the 28th DS1 channel to the **Receive** input of the DS1 test set.
5. Set the test set options for ESF/B8ZS, and run a standard BERT using QRSS or other preferred test pattern(s).
6. All alarms should clear on the MX2800, and the BERT should run error free. Troubleshoot as necessary.
7. Leave this test setup in place, as it will be used during the redundancy testing portion of this document. Proceed to *Verifying Alarm Notification* on page A-7.

## DS1 to DS3 Head-to-Head Test

This test is ordinarily a two-person operation, and it is the preferred means of testing system and cabling integrity. It tests one DS1 channel at a time, using a DS1 test set at the DSX-1 cross-connect panel or connecting equipment and a DS3 test set at the DSX-3 or connecting equipment location.

Equipment Required:

- 1 DS1 test set capable of running a BERT
- 1 DS3 test set capable of accessing and running a BERT on a single DS1

Follow these procedures to execute the head-to-head test.

1. At the DSX-3 cross-connect panel or connecting equipment, properly connect the DS3 test set to the DS3 coming from the MX2800. *Confirm transmit and receive integrity*, an integral step in the process.
2. Configure the DS3 test set for C-Bit Framing, the appropriate LBO, and set to drop out DS1 #1. Configure the DS1 BERT to run in ESF/B8ZS mode using QRSS or other preferred test pattern. Confirm that the MX2800 sees a good DS3 signal. The **DS3 STATUS** LED should be solid green on the Active Controller, and the DS3 test set should be in frame synchronization with the MX2800.
3. At the DSX-1 cross-connect bay or connecting equipment, connect the DS1 test set to the first DS1 channel of the MX2800. Configure the test set for the same framing, line code, and BERT pattern as the DS3 test set. Confirm a good, error-free BERT for a minimal period, such as 15 seconds.
4. Repeat for DS1 channels 2-28 by moving the DS1 test cables and reconfiguring the DS3 test set to drop out the appropriate DS1 channel under test.
5. The MX2800 condition is in an alarm because of the previously tested and now unterminated DS1 ports, but this should not prohibit a successful BERT between the DS1 and DS3 test sets on the channel under test.
6. Leave this test setup in place, as it will be used during the redundancy testing portion of this document. Proceed to *Verifying Alarm Notification* on page A-7.

---

## DS1 to DS3 (Hard) Loopback

This test requires minimal test equipment, tests one DS1 at a time, and can be performed single-handedly. It does not verify DS3 cabling integrity (transmit Vs. receive) to the DSX3 or connecting equipment.

Equipment Required:

- 1 DS1 test set capable of running a BERT test
- 1 DS3 DSX test cord

Follow these procedures to test one DS1 at a time:

1. At the DSX-3 cross-connect panel or connecting equipment, loop the DS3 from the MX2800 back on itself. Confirm that the MX2800 sees a good DS3 signal. The **DS3 STATUS** LED should be solid green on the Active Controller, and the DS3 test set should be in frame synchronization with the MX2800.
2. At the DSX-1 cross-connect bay or connecting equipment, insert the **Transmit** output of the DS1 test set to the DS1 **Input** of the first channel of the MX2800. Connect the **Receive** input of the test set to the **Output** of the first DS1 channel of the MX2800.
3. Configure the DS1 test set for ESF/B8ZS and the desired BERT pattern, such as QRSS.
4. All alarms should clear on the MX2800, and the BERT should run error free. Troubleshoot as necessary.
5. Repeat the above procedure for DS1 channels 2-28. The MX2800 will be in an alarm condition because of the unterminated DS1 ports, but this condition should not prohibit a successful BERT.
6. Leave this test setup in place, as it will be used during the redundancy testing portion of this document. Proceed to [Verifying Alarm Notification](#).

## 5. VERIFYING ALARM NOTIFICATION

The MX2800 has two sets of alarm relay contacts available for connection to external alarm systems. They are located on the back panel and are designated as **Critical**, and **Noncritical**. Normally **Open** and normally **Closed** contacts are available for each of the relay outputs. The Critical alarm is activated when the DS3 port experiences a Loss of Signal (LOS) event. The Noncritical alarm is activated when one of the 28 DS1 ports experiences a Loss of Signal event. Detailed alarm testing procedures are described below.

### Critical Alarm Relay Test

This test actuates the Critical alarm relay contacts.

Equipment Required:

- 1 DS3 DSX test cord

Follow these procedures to test one the critical alarm relay.

1. Ensure that the DS3 is not in alarm. To do this, place a hard loopback of the DS3 toward the MX2800 using a test cord at the DSX-3 cross-connect panel or connecting equipment.
2. With the loopback in place, all alarms should clear on the Controller Module DS3 port. The **DS3 STATUS** LED should be solid green on the Active Controller).

3. Remove the loopback from the DS3 and ensure that no other DS3 signal is entering the MX2800 through the DSX-3 cross-connect bay or connecting equipment, such as DCS.
4. The MX2800 should go into Critical alarm, thus closing the relay contacts and sending the alarm to the alarm monitoring equipment.
5. Verify that the alarm is being properly reported as a Critical alarm.

## Noncritical Alarm Relay Test

This test actuates the Noncritical alarm relay contacts.

Equipment Required:

- 1 DS3 DSX test cord

Follow these procedures to test one the noncritical alarm relay.

1. Ensure that the DS3 is not in alarm. The **DS3 STATUS** LED should be solid green on the Active Controller. To do this, re-install a hard loopback of the DS3 toward the MX2800.
2. Ensure that the 28 DS1s are out of alarm. To accomplish this, proceed as follows:
  - a. At the DSX-1 cross-connect, insert the **Transmit** of the DS1 test set into the **Input** of the first DS1 channel of the MX2800. Install a bantam test cord from the **Output** of the first DS1 channel to the **Input** of the second DS1 channel. Then connect a second bantam test cord from the **Output** of the second DS1 channel to the **Input** of the third DS1.
  - b. Repeat this procedure for all 28 DS1 channels. Connect the **Output** of the 28th DS1 channel to the **Receive** of the DS1 test set. Configure the test set for ESF/B8ZS and run a standard BERT test using QRSS or other preferred test pattern(s).
3. Nothing should be in alarm. The **DS1 STATUS** LEDs should all be solid green on the Active Controller. Remove any one of the bantam cords from the DSX bay. Removing this cord causes a DS1 LOS alarm, which results in the actuation of the Noncritical alarm relay.
4. Verify that the Noncritical alarms are being properly reported to the office alarm monitoring equipment.

## 6. VERIFYING SYSTEM REDUNDANCY

This section addresses the redundancy features of the MX2800. The MX2800 supports redundancy of both the Power Supply and Controller Modules. The equipment configuration (nonredundant vs. redundant and type of power redundancy) are useful in determining what can and cannot be tested. The following sections describe the tests for various configurations.

### Power Supply Redundancy

When installed, the MX2800 can be wired to have either one or two –48 VDC power feeds **A** and **B**. In addition, the MX2800 chassis can be equipped with either one or two Power Supply modules. Test scenarios for the two most common configurations follow. Testing of the other configurations is a subset of the following.

### Single Power Supply Module / Dual Power Feeds

When the MX2800 is equipped with only a single Power Supply module, there is no protection against a failure of the module itself. However, the single Power Supply is capable of utilizing the **A** and **B** power feeds to protect against a failure in one of the power sources feeding the shelf. To verify that the MX2800 is properly utilizing the **A** and **B** power feeds, the following procedure is recommended:

1. With the MX2800 installed and operating normally, go to the fuse panel at the top of the bay and remove the fuse corresponding to the **A** power feed for the MX2800 shelf. Removing this fuse should have no effect on the operation of the shelf because the MX2800 is operating on the **B** power feed.
2. Reinsert the fuse for the **A** power feed.
3. Now, remove the **B** power feed fuse for the MX2800 shelf. Once again, there should be no effect on the operation of the shelf because the MX2800 is operating on the **A** power feed.
4. Reinsert the fuse for the **B** power feed.

### Dual Power Supply Modules / Dual Power Feeds

When the MX2800 is equipped with two Power Supply modules and also wired to support dual power feeds, the shelf is protected against a failure of either of the Power Supply cards or a failure of one of the power sources feeding the shelf. Use the following procedure to confirm the operation of this fully redundant configuration:

1. With the MX2800 installed and operating normally, remove the **A** Power Supply card (the one on the left). Removing this card should have no effect on the operation of the shelf because the MX2800 is operating on the **B** Power Supply.
2. Go to the fuse panel at the top of the bay and remove the fuse corresponding to the **A** power feed. Removing this fuse should have no effect on the operation of the shelf because the **B** Power Supply is running on the **B** power feed.
3. Reinsert the fuse for the **A** power feed.
4. Remove the fuse corresponding to the **B** power feed to the shelf. Doing so should have no effect on the operation of the shelf as the **B** Power Supply is operating on the **A** power feed.
5. Reinsert the fuse for the **B** power feed.
6. Reinsert the **A** Power Supply into the MX2800 chassis.
7. Remove the **B** Power Supply card (the one on the right). Doing so should have no effect on the operation of the shelf because the MX2800 is operating on the **A** Power Supply.
8. Go to the fuse panel at the top of the bay and remove the fuse corresponding to the **A** power feed. Removing this fuse should have no effect on the operation of the shelf because the **A** Power Supply is now running on the **B** power feed.
9. Reinsert the fuse for the **A** power feed.
10. Remove the fuse corresponding to the **B** power feed to the shelf. Removing this fuse should have no effect on the operation of the shelf as the **A** Power Supply is operating on the **A** power feed.
11. Reinsert the fuse for the **B** power feed.
12. Reinsert the **B** Power Supply into the MX2800 chassis.

13. Confirm that both power supplies and power feeds are functioning as normal. Front panel LEDs identify problems with the power supplies, but the inputs can be tested only via VOM.

## Controller Card Redundancy

The MX2800 can be equipped with either one or two Controller cards. The Controller contains all of the MX2800's critical circuitry, including the DS3 interface, DS1 interfaces, management and communications hardware/firmware, etc. If the MX2800 is equipped with only one Controller, there is no protection against failure. If a failure does occur to the Controller, an alarm is initiated; and the front panel LEDs reflect the condition. The **ACT** LED is either solid or flashing red.

If the MX2800 is equipped with two Controller modules, all traffic is protected and can be switched over to the Standby Controller in the event of a card failure. The following procedures demonstrate the functionality of a Controller switchover:

1. Using the BERT setup that should still be in place from previous testing, ensure that the system is still passing traffic error free.
2. Log into the MX2800 (if necessary) via the craft port to get to the Main Menu screen. From there, select Configuration, followed by Network Interface and Active Controller.
3. This procedure shows which Controller (**A** or **B**) is currently Active. If the **A** Controller is Active, select Controller **B** as the Active Controller. Doing so forces a switch to the **B** Controller, which is acting as a hot standby. If the **B** Controller is the Active Controller, force a switch to the **A** Controller.
4. Traffic is interrupted momentarily during the switch but quickly returns to error-free performance again on the new Controller.
5. Although either Controller can be the Active Controller, for consistency, the **A** Controller should be left as the Active one.

---

### NOTE

Repeat the log-in sequence in Step 2 after each protection switch.

---

## 7. RESTORING DEFAULT SETTINGS

After all Acceptance Tests have been successfully completed, the MX2800 can be restored to its default settings by following the procedures below:

1. Log into the MX2800, if necessary, via the craft port. From the Main Menu, select Configuration, followed by Utilities and Load Default Settings.
2. Once the settings have been retrieved and loaded into the system, Command Accepted appears at the bottom of the screen. The Standby Controller always maintains an exact copy of the Active Controller's attributes. Confirm that all settings are as expected via the craft port.
3. Normalize all loopbacks as appropriate, and restore all cabling and DSX panels to normal.

Office and Autonomous alarms may be generated as a result of performing Step 3, above. DS3 alarms can be cleared by looping the DS3 back toward the MX2800 and setting the MX2800 Timing to Local via the

craft port by selecting Configuration, Network Interface and Timing from the Main Menu, or by ensuring continuity to and proper provisioning of the MX2800 and connecting equipment.

At the DS1 level, the MX2800 has three Service States. They operate as follows:

- Disabled – No signal continuity exists through the MX2800, and no alarms are detected or transmitted.
- Enabled – Signal continuity and alarming are always enabled.
- Auto Enable (default) – Signal continuity and alarming exist only after a DS1 signal is detected at the DS1 input to the MX2800. Once a signal is detected, the only way to disable alarming is to momentarily toggle the DS1 channel to the Disable state as follows:

From the Main Menu, select Configuration, T1/E1 Interface and T1 State. From the T1/E1 State screen, enter the DS1# in question; then disable signal continuity and alarm transmission. Repeat the process of selecting the DS1 from the T1/E1 State screen, but this time select Auto Enable to once again provision the slot/channel for service. No alarms are transmitted until a DS1 signal has been detected and removed, or an unframed signal is detected.

## **8. CONFIGURING THE SYSTEM FOR TRAFFIC READINESS**

After the previous tests are successfully completed and the default settings are restored, the MX2800 can be considered ready for customer traffic. Specific provisioning of the DS3, DS1, and other options is determined by circuit orders and local practices.

## 9. SIGNING-OFF THE MX2800 ATP CHECKLIST

Use [Table A-1](#) to identify the MX2800 configuration, identify tests performed, etc.

**Table A-1. MX2800 ATP Checklist**

Acceptance Test Procedure Steps	Completed
<b>Verifying the Installed Options</b>	
Dual Power Supplies / Dual Power Feeds	
Dual Power Supplies / Single Power Feed	
Single Power Supply / Dual Power Feeds	
Single Power Supply / Single Power Feed	
Dual Controllers	
Single Controller	
<b>Configuring the System</b>	
Accessing the Craft Port	
Provisioning the DS3 Port	
Provisioning the DS1 Ports	
Alarm Relay Configuration	
<b>Verifying the Data Integrity</b>	
DS1 Daisy-Chain to DS3 (Hard) Loopback	
DS1 to DS3 "Head-to-Head" Test	
DS1 to DS3 (Hard) Loopback	
<b>Verifying Alarm Notification</b>	
Critical Alarm Relay Test	
Noncritical Alarm Relay Test	
<b>Verifying System Redundancy</b>	
Redundancy Tests (Power Supply and Power Feed as appropriate)	
Controller Card Redundancy Test	
Autonomous Alarm Reporting	
<b>Restoring Default Settings</b>	
<b>Configuring the System for Traffic Readiness</b>	

NAME:	DATE:
LOCATION:	RELAY RACK:



## Appendix B Pinouts

**Table B-1**, **Table B-2**, **Table B-3**, and **Table B-4** list the pin assignments for the connectors located on the MX2800. For more information on these connectors, refer to *Section 2, Installation and Operation*.

**Table B-1. Craft Port Pin Assignments**

RJ Pin#	DB-9	Function	Direction
1	5	GND	
2	7	RTS	I
3	3	TD	I
4	6	DSR	O
5	2	RD	O
6	8	CTS*	O
7	4	DTR	I
8	1	DCD	O
-	9	not used	-

\* Used for hardware flow control.

**Table B-2. LAN Port Pin Assignments**

Pin	Name	Description
1	TD+	The positive signal for the TD differential pair. This signal contains the serial output data stream transmitted onto the network.
2	TD-	The negative signal for the TD differential pair (pins 1 and 2).
3	RD+	The positive signal for the RD differential pair. This signal contains the serial input data stream received from the network.
4, 5	N/A	not used
6	RD-	The negative signal for the RD differential pair (pins 3 and 6).
7, 8	N/A	not used

**Table B-3. Modem Port Pin Assignment**

Pin	Description
1,2,3	Not used
4	tip
5	Ring
6,7,8	Not used

**NOTE**

The modem port assignment apply only to units equipped with an internal modem (P/N4200290L1, P/N4200290L2, P/N4200290L3, and P/N4200290L4).

**Table B-4. Amphenol Pin Assignments**

Pin	Function	Pin	Function
1	RING 1	33	TIP 1
2	RING 2	34	TIP 2
3	RING 3	35	TIP 3
4	RING 4	36	TIP 4
5	RING 5	37	TIP 5
6	RING 6	38	TIP 6
7	RING 7	39	TIP 7
8	RING 8	40	TIP 8
9	RING 9	41	TIP 9
10	RING 10	42	TIP 10
11	RING 11	43	TIP 11
12	RING 12	44	TIP 12
13	RING 13	45	TIP 13
14	RING 14	46	TIP 14
15	RING 15	47	TIP 15
16	RING 16	48	TIP 16
17	RING 17	49	TIP 17

**Table B-4. Amphenol Pin Assignments (Continued)**

<b>Pin</b>	<b>Function</b>	<b>Pin</b>	<b>Function</b>
18	RING 18	50	TIP 18
19	RING 19	51	TIP 19
20	RING 20	52	TIP 20
21	RING 21	53	TIP 21
22	RING 22	54	TIP 22
23	RING 23	55	TIP 23
24	RING 24	56	TIP 24
25	RING 25	57	TIP 25
26	RING 26	58	TIP 26
27	RING 27	59	TIP 27
28	RING 28	60	TIP 28
29	N/A	61	N/A
30	N/A	62	N/A
31	N/A	63	N/A
32	FGND	64	FGND

**NOTE**

**Table B-4** applies to both the **In** and **Out** DSX1/E1 amphenol connectors.

This page is intentionally blank.

# Appendix C

## Specifications Summary

### 1. INTRODUCTION

This appendix describes the standard specifications and features incorporated in the MX2800.

### 2. SPECIFICATIONS AND FEATURES

The specification and features paragraphs are as follows:

- DSX-3 Network Interface
- DSX-1 Interface(s)
- Clocking
- Loopbacks
- Management
- Alarms
- Agency Approvals
- Environment
- Power
- Physical

#### **DSX-3 Network Interface**

Channelized DS3

Line length: short (less than 225 ft.) and long (greater than 225 ft.)

Framing format: M13 and C-bit parity

Line rate: 44.736 Mbps

Line interface: dual 75-ohm BNC coax female connectors

#### **DSX-1 Interface(s)**

Line length: 0-655 feet

Line rate: 1.544 Mbps

Line code: AMI or B8ZS

Line interface(s): two 64-pin amphenol connectors

## Clocking

Network: receive from DS3 network

Local: internally generated

External: receive from T1/E1 port or BITS clock from wire-wrap pins on back of chassis

## Loopbacks

### DS3 Network

ANSI T1.107 compatible loopbacks

Line loopbacks

### DS2 Interfaces

DS2 network loopbacks

### DSX-1 Interfaces

Local and network loopbacks

## Management

Supported by Total Access Element Management System (JAVA application that provides configuration, performance, network assurance, and provisioning functions). Refer to [www.adtran.com](http://www.adtran.com) website product area for additional information.

Supported by ADVISION (graphical user interface (GUI) SNMP management tool integrated into HP OpenView UNIX platform on SUN Solaris or HP-UX). Refer to [www.adtran.com](http://www.adtran.com) website product area for additional information.

### VT100 Terminal Interface

RJ-48, EIA-232 compatible, female DB-9 adapter provided

### Integrated Modem Interface (4200290L1, 4200290L2, 4200290L3, 4200290L4)

Dial up access for VT100, SNMP, or Telnet

Dial out "Cry for help"

### SNMP/Telnet

Integrated 10Base-T Ethernet

MIB II (RFC 1213), RFC 1215, and RFC 1407 compliant.

ADTRAN Enterprise MIB for extended monitoring and control/configuration

## Alarms

External alarm contacts for critical, major, and minor alarms  
Normally Open (NO) and Normally Closed (NC) pinout  
Front panel alarm cutoff switch

## Agency Approvals

FCC Part 15, Class A, Part 68  
Industry Canada CS03  
UL and CUL  
NEBS Level 3

## Environment

Operating:  $-40^{\circ}\text{C}$  to  $+65^{\circ}\text{C}$  ( $-40^{\circ}\text{F}$  to  $149^{\circ}\text{F}$ )  
Storage:  $-40^{\circ}\text{C}$  to  $+85^{\circ}\text{C}$  ( $-40^{\circ}\text{F}$  to  $185^{\circ}\text{F}$ )  
Relative Humidity: Up to 95%, nonconducting

## Power

AC version: 120VAC, 27W  
DC version:  $-48$  VDC, 30 W  
DC version:  $+24$ VDC, 30 W

## Physical

Dimensions: 7.86" D x 17.0" W x 1.7" H  
Weight: 5.5 lbs. (redundant); 4.5 lbs. (nonredundant)

This page is intentionally blank.



## Appendix D Acronyms/Abbreviations

### A

**ACO** ..... alarm cut off  
**ACT** ..... active  
**AIS** ..... alarm indication signal  
**ALM** ..... alarm  
**AMI** ..... alternate mark inversion  
**Amp** ..... amphenol  
**ANSI** ..... American National Standards Institute  
**async** ..... asynchronous

### B

**BERT** ..... bit error rate test  
**bps** ..... bits per second  
**BPV** ..... bipolar violation

### C

**CA** ..... communications equipment available  
**CAIS** ..... carrier side alarm indication signal  
**CCITT** ..... Consultive Committee for International Telephony and Telegraphy  
**CCV** ..... C-bit coding violation  
**CD** ..... carrier detect  
**CES** ..... C-bit errored seconds  
**CO** ..... central office  
**CPE** ..... customer premise equipment  
**CRC** ..... cyclic redundancy check  
**CS** ..... clear to send  
**CSES** ..... C-bit severely errored seconds  
**CSU** ..... channel service unit  
**CTS** ..... clear to send

---

CV..... coding violation

## D

dB ..... decibel

DBU..... dial backup

DCD..... data carrier detect

DCE..... data communications equipment

DDS ..... digital data service

DLCI ..... data link connection identifier

DS1 ..... digital signal Level 1

DS3 ..... digital signal Level 3

DSR ..... data set ready

DSU ..... data service unit

DSX-1 ..... digital signal cross connect, Level 1

DTE ..... data terminal equipment

DTR..... data terminal ready

## E

ES ..... errored seconds

Eq ..... equipment

Eqpt..... equipment

EXZ..... excessive zeros

## F

FBE..... F-bit errors

FCC ..... Federal Communications Commission

FDL ..... facility datalink

FEAC ..... far-end alarm and control

FEBE..... far-end block error

## H

HSSI ..... high-speed serial interface

## I

IP ..... internet protocol

## K

KA ..... keep alive

**L**

<b>LAIS</b> .....	loop-side alarm indication signal
<b>LAN</b> .....	local area network
<b>LCV</b> .....	line coding violation
<b>LED</b> .....	light emitting diode
<b>LES</b> .....	line errored seconds
<b>LIU</b> .....	line interface unit
<b>LL</b> .....	local loopback
<b>LOF</b> .....	loss of framing
<b>LOS</b> .....	loss of signal

**M**

<b>MBE</b> .....	M-bit errors
<b>Mbps</b> .....	megabits per second
<b>MIB</b> .....	management information base
<b>ms</b> .....	millisecond

**N**

<b>NC</b> .....	normally closed
<b>NI</b> .....	network interface
<b>NMS</b> .....	network management system
<b>NO</b> .....	normally open
<b>NRZ</b> .....	non-return to zero
<b>NSA</b> .....	non-service-affecting

**O**

<b>OCU</b> .....	office channel unit
<b>OOF</b> .....	out of frame
<b>OOS</b> .....	out of service

**P**

<b>PCV</b> .....	P-bit coding violation
<b>PES</b> .....	P-bit errored seconds
<b>POP</b> .....	point of presence
<b>PPP</b> .....	point-to-point protocol
<b>PRF</b> .....	performance
<b>PSES</b> .....	P-bit severely errored seconds

---

PSTN..... public switched telephone network

PVC..... permanent virtual circuit

## R

RD..... receive data

RDL..... remote digital loopback

RL..... remote loopback

RMA..... return material authorization

RS..... request to send

RTS..... request to send

Rx..... receive

## S

SA..... service affecting

SEFS..... severely errored framing seconds

SES..... severely errored seconds

SLIP..... serial line internet protocol

SNMP..... simple network management protocol

SONET..... synchronous optical network

SR..... data set ready

SW56..... switched 56

sync..... synchronous

## T

TA..... terminal equipment available

TD..... transmit data

TDM..... time division multiplexing

TM..... test mode

TR..... data terminal ready

Tx..... transmit

## U

UAS..... unavailable seconds

## W

WAN..... wide area network

**X**

**XCV**..... excessive coding violations

This page is intentionally blank.

## Appendix E

### Glossary

**10Base-T** Ethernet connector which implements the IEEE standard on 24-gauge, unshielded twisted-pair wiring.

#### A

**AMI** Alternate Mark Inversion. A bipolar line-coding format in T1 transmission systems whereby successive ones are alternately inverted.

**ANSI** American National Standards Institute. A nonprofit organization that coordinates voluntary standards activities in the United States.

**asynchronous** A method of data transmission which allows characters to be sent at irregular intervals by preceding each character with a start bit followed by a stop bit.

#### B

**bandwidth** The bandwidth determines the rate at which information can be sent through a channel (the greater the bandwidth, the more information that can be sent in a given amount of time).

**baud rate** A measure of transmission speed over an analog phone line. Baud rate measures the shortest signaling elements per second in the analog signal that a modem sends over an analog phone line. Does not necessarily equal the bit rate.

**BERT** Bit error rate test. A test that uses any of a number of stress patterns to test T3, T1, FT1, and DDS circuits.

**bipolar** A signal containing both positive and negative amplitude components.

**bipolar violation** See *BPV*.

**bit** A binary digit representing a signal, wave, or state as either a one or a zero. A bit is the smallest unit of information a computer can process.

**bit error** The receipt of an encoded bit that differs from what was sent by the transmitter.

**bit rate** The speed at which bits are transmitted, usually expressed in bits per second (bps).

**bps** Bits per second. The number of bits passing a specific point per second. Examples of common rates are kbps (one thousand bits per second) and Mbps (one million bits per second). T3 operates at 44.736 Mbps.

---

<b>BPV</b>	Bipolar violation. A violation in the alternate mark inversion (AMI) line code in which consecutive 1s are represented by pulses of opposite polarity. BPVs that are not intentional (B8ZS) are counted as errors. Could also be the presence of two consecutive 1 bits of the same polarity on the T-carrier line.
<b>bridge</b>	A data communications device that connects two or more networks and forwards packets between them.
<b>byte</b>	Generally, an 8-bit quantity of information. This term is used mainly in referring to parallel data transfer, semiconductor capacity, and data storage.
<b>C</b>	
<b>carrier</b>	The provider of the telecommunication services to the customer site. Carriers can be local telephone companies, regional telephone companies, or any inter-exchange carrier such as AT&T, Sprint, or MCI.
<b>C-bit</b>	An overhead bit in the DS3 string not used for framing, parity, or alarm indication.
<b>CCITT</b>	Consultive Committee for International Telephony and Telegraphy. A standards organization that devises and proposes recommendations for international communications. See also <i>ANSI</i> .
<b>CD</b>	Carrier detect. A signal generated by a modem or DSU/CSU indicating the presence of a carrier signal on a communications link.
<b>channel</b>	A transmission path between two or more termination points, also called a circuit, facility, line, link, or path.
<b>channel bank</b>	Equipment in a telephone central office or customer premises that performs multiplexing of lower-speed digital channels into a higher-speed composite channel. The channel bank also detects and transmits signaling information for each channel, thereby transmitting framing information so that time slots allocated to each channel can be identified by the receiver.
<b>channel service unit</b>	See <i>CSU</i> .
<b>clocking</b>	An oscillator-generated signal that provides a timing reference for a transmission link. A clock provides signals used in a transmission system to control the timing of certain functions. The clock has two functions: (1) to generate periodic signals for synchronization, and (2) to provide a time base.
<b>CPE</b>	Customer premises equipment. All telecommunications terminal equipment located on the customer premises, including telephone sets, private branch exchanges (PBXs), data terminals, and customer-owned, coin-operated telephones.



<b>craft port</b>	The data communications interface between the MX2800 and the control terminal. The control terminal is used to communicate commands to the unit.
<b>CSU</b>	Channel service unit. A device used to connect a digital phone line coming in from the phone company to either a multiplexer, channel bank, or directly to another device producing a digital signal; for example, a digital PBX, a PC, or data communications device. A CSU performs certain line-conditioning and equalization functions and responds to loopback commands sent from the central office. A CSU also regenerates digital signals. It monitors them for problems and provides a means of testing the digital circuit.
<b>CTS</b>	Clear to send. A signal on the DTE interface indicating that the DCE is clear to send data.
<b>D</b>	
<b>data communications equipment</b>	See <a href="#">DCE</a> .
<b>data service unit</b>	See <a href="#">DSU</a> .
<b>dB</b>	Decibel. A unit of measure of signal strength, usually the relation between a transmitted signal and a standard signal source.
<b>DCE</b>	Data communications equipment. Device that provides all the functions required for connection to telephone company lines and for converting signals between telephone lines and DTE. Also see <a href="#">DTE</a> .
<b>DDS</b>	Digital data service. A private line digital service for transmitting data end-to-end at speeds of 2.4, 4.8, 9.6, and 56 kbps (and, in some cases, 19.2, 38.4, or 64 kbps). The systems can use central hub offices for obtaining test access, bridging legs of multi-point circuits, and cross connecting equipment. DDS is offered on an inter-LATA (local access and transport area) basis by AT&T and on an intra-LATA basis by the Bell operating companies.
<b>delay</b>	The amount of time by which a signal is delayed. A round-trip transmission delay measurement helps detect possible causes of protocol timeouts.
<b>DLCI</b>	Datalink communications identifier. A unique number assigned to a PVC endpoint in a frame relay network. Identifies a particular PVC endpoint within a user's access channel in a frame relay network and has local significance only to that channel.
<b>DS1</b>	Digital signal Level 1. Twenty-four DS0 channels make up one DS1. (Total bandwidth is 1.544 Mbps.)
<b>DS3</b>	Digital signal Level 3. Equivalent of 28 DS1s and 672 DS0s. (Total bandwidth is 44.736 Mbps.)

---

<b>DSU</b>	Data service unit. A device designed to transmit and receive digital data on digital transmission facilities.
<b>DTE</b>	Data terminal equipment. The end-user terminal or computer that plugs into the termination point (DCE) of a communications circuit. The main difference between the DCE and the DTE is that Pins 2 and 3 are reversed.
<b>E</b>	
<b>E1</b>	Transmission rates of 2.048 Mbps are available on T1 communication lines. See also <i>T1</i> .
<b>end device</b>	The ultimate source or destination of data flowing through a network (sometimes referred to as DTE).
<b>end user</b>	Subscriber who uses (rather than provides) telecommunications services.
<b>ES</b>	Errored seconds. A second with one or more coding violations (CVs).
<b>Ethernet</b>	Transmission protocol for packet-switching LANs.
<b>F</b>	
<b>facilities</b>	The equipment used by carriers to provide communication services.
<b>far end</b>	The distant end to that being considered. Not the end where testing is being carried out.
<b>FCC</b>	Federal Communications Commission. The U.S. federal agency responsible for regulating interstate and international communications by radio, TV, wire, satellite, and cable.
<b>FDL</b>	Facility datalink. FDL bits provide overhead communication between the terminal equipment in ESF framing.
<b>G</b>	
<b>gateway</b>	A device which enables information to be exchanged between two dissimilar systems or networks.
<b>H</b>	
<b>host computer</b>	The primary or controlling computer in a multiple computer operation.
<b>I</b>	
<b>idle code</b>	In a T3 circuit, an idle code consists of a sequence of 1100 over the entire payload bandwidth.
<b>in-band</b>	Signaling (dialing, loopbacks, management, configuration, etc.) over the same channel used for data.

---

<b>IP</b>	Internet protocol. A protocol which provides for transmitting blocks of data between hosts identified by fixed-length addresses.
<b>L</b>	
<b>LAN</b>	Local area network. A privately owned network that offers high-speed communications channels to connect information processing equipment in a limited geographic area.
<b>local loopback</b>	
<b>(LL)</b>	A type of test used to verify the operation of the local terminal equipment, the CSU, and the connection between the two. The signal from the DTE is looped back by the CSU and is sent back to the DTE.
<b>loopback</b>	The technique for testing the processing circuitry of a communications device. May be initiated locally or remotely via a telecommunications circuit. Device being tested will echo back received test data. The results are compared with the original data.
<b>LOS</b>	Loss of signal. Defined as a line state in which no pulses are received for 175 bit positions.
<b>M</b>	
<b>M13</b>	DS1/DS3 multiplexer that combines up to 28 DS1 channels into one DS3 channel. Uses two-stage, bit synchronous TDM.
<b>Mbps</b>	Megabits per second (one million bits per second).
<b>MIB</b>	Management information base. A database of network management information used by SNMP.
<b>modem</b>	Acronym for modulator/demodulator. Equipment that converts digital signals to and from analog signals. Used to send digital signals over analog phone lines.
<b>monitor</b>	To watch or listen to a signal non intrusively.
<b>multi-point circuit</b>	A single communications circuit that has more than two terminations.
<b>N</b>	
<b>NC</b>	Normally closed. Relay switch contacts that remain closed when inactive.
<b>near end</b>	The on-site unit.
<b>NI</b>	Network interface. The demarcation point between the CPE and the PSTN.
<b>NO</b>	Normally open. Relay switch contacts that remain open when inactive.

---

**NRZ** Non return to zero. A mode in which the digital level is low for a 0 bit and high for a 1 bit, and does not return to zero between successive 1 bits.

## O

**out-of-band** Signaling that is separated from the channel carrying information (voice, data, video, etc.). Typically the separation is accomplished by a filter. The signaling includes dialing and other supervisory signals.

## P

**point-to-point** Type of communications link that connects a single device to another single device, such as a remote terminal to a host computer.

**POP** Point of presence. Physical place within a LATA (local access and transport area) where a long distance carrier or a cellular provider interfaces with the network of the local exchange carrier (LEC). A POP is usually a building serving as the point of termination which houses switches and transmission equipment.

**protocol** A set of rules controlling the orderly exchange of information between stations in data communications networks or systems.

**PSTN** Public switched telephone network. Usually refers to the worldwide voice telephone network available for public use.

## R

**red alarm** Unframed all ones signal (keep alive signal). A red alarm is declared on detection of LOS or OOF not caused by an alarm indication signal (AIS) that persists for more than two seconds.

**remote configuration** A feature designed into ADTRAN products that allows remote units to be configured from a local unit or a VT100-compatible terminal.

**router** A device that supports communications between networks. Routers are similar to bridges, except that routers provide more functionality (such as finding the best route between networks and providing network management capabilities).

## S

**service** The provision of telecommunications to customers by a common carrier, administration, or private operating agency using voice, data, and/or video technologies.

**service provider** A company that delivers or sells a telecom service.

**SES** Severely errored seconds. A second in which more than 320 code violations (CVs) occurred or an OOF condition occurred.

**signaling** Communication between switches to set up and terminate calls.

<b>SNMP</b>	Simple network management protocol. A control and reporting scheme widely used to manage devices from various vendors. SNMP operates on top of the Internet protocol.
<b>SONET</b>	Synchronous optical network. A standard format for transporting a wide range of digital telecommunications services over optical fiber. SONET is characterized by standard line rates, optical interfaces, and signal formats.
<b>SR</b>	Data set ready. A signal on the DTE interface that indicates if a connection exists and if the devices are ready to start handshaking control signals so communications can begin.
<b>synchronous</b>	Communications in which the timing is achieved by sharing a single clock. Each end of the transmission synchronizes itself with the use of clocks and information sent along with the transmitted data.
<b>T</b>	
<b>T1</b>	Transmission rates of 1.544 Mbps are available on T1 communication lines. Also referred to as digital signal Level 1 (DS-1). See also <a href="#">EI</a> .
<b>T3</b>	Transmission rates of 44.736 Mbps are available on T3 communication lines. Also referred to as digital signal Level 3 (DS-3).
<b>TDM</b>	Time division multiplexing. A technique for transmitting two or more signals at the same time over a single communication medium. This is accomplished by allocating channels to the bandwidth for specific increments of time.
<b>Telnet</b>	The standard TCP/IP remote login protocol specified in RFC-854.
<b>transceiver</b>	A combination of transmitter and receiver, providing both output and input interfaces within a single device.
<b>transmission</b>	The signaling of data over telecommunications channels.
<b>V</b>	
<b>V.35</b>	A standard for trunk interface between a network access device and a packet network that defines signaling for data rates greater than 19.2 kbps.
<b>VT100</b>	A non intelligent terminal or terminal emulation mode used for asynchronous communications. Used to configure the MX2800.
<b>W</b>	
<b>WAN</b>	Wide area network. A communications network serving geographically separate areas. A WAN typically extends a LAN outside the building to link to other LANs over telephone lines.

**Y****yellow alarm**

A T3 yellow alarm is an indication sent back toward the source of a failed transmit circuit in a DS3 two-way transmission path. The X-bits (X1 and X2) are set to zero.

# Appendix F Warranty

## 1. WARRANTY AND CUSTOMER SERVICE

ADTRAN will replace or repair this product within the warranty period if it does not meet its published specifications or fails while in service. Warranty information can be found at [www.adtran.com/warranty](http://www.adtran.com/warranty).

Refer to the following subsections for sales, support, Customer and Product Service (CAPS) requests, or further information.

## 2. ADTRAN SALES

Pricing/Availability:  
800-827-0807

## 3. ADTRAN TECHNICAL SUPPORT

Pre-Sales Applications/Post-Sales Technical Assistance:  
800-726-8663

Standard hours: Monday - Friday, 7 a.m. - 7 p.m. CST  
Emergency hours: 7 days/week, 24 hours/day

## 4. ADTRAN REPAIR/CAPS

Return for Repair/Upgrade:  
(256) 963-8722

## 5. REPAIR AND RETURN ADDRESS

Contact CAPS prior to returning equipment to ADTRAN.

ADTRAN, Inc.  
CAPS Department  
901 Explorer Boulevard  
Huntsville, Alabama 35806-2807

This page is intentionally blank.



# Index

## Numerics

- 24 Hour Alarm History
  - DS2 Statistics menu 5-9
  - DS3 Statistics menu 5-2

## A

- acknowledgment messages
  - All Right 9-3
  - In Progress 9-3
- ACT LED, active cards 2-16
- ACT LED, standby cards 2-17
- Active Controller menu 3-6
- Active state, Card A/Card B 4-5
- agent, SNMP 1-3
- AIS
  - 24 Hour Alarm History (DS3 statistics) 5-2
  - Remote status 4-3
  - State, DS2 4-6
  - State, DS3 4-2
- AIS Carrier Alarms 5-13
- AIS Loop Alarms 5-13
- alarm events 9-11
- Alarm Log 5-14
- Alarm menu
  - DS3 State 4-2
  - System State 4-4
- alarms
  - system 3-34
- ALM LED, active cards 2-16
- ALM LED, standby cards 2-17
- Analog Loopback, remote all T1/E1 6-8
- Analog Network loopback test 6-3
- Answer on Ring menu 3-20
- Auto Save menu 3-38
- autonomous messages 9-4, 9-11

## B

- backup protection
  - non-redundant power mode 8-1
  - power supply and source recovery mode 8-2
  - power supply recovery mode 8-2
- battery backup, overview 1-4

- Battery Low, Power Supply State 4-4
- baud rate, setting 3-20

## BERT

- CSU Loopback w/ 6-4
- Line 6-5
- Bipolar Violations 5-13

## blue alarm

- DS2 State 4-6
- network state 4-2
- Remote status 4-3

## breakout panel

- overview 1-3

## C

### CAIS

- T1/E1 State 4-6

### Card A/Card B

- Active state 4-5
- Failure 4-5
- Not Installed 4-5
- Stand By 4-5

### Card A/Card B menu 4-5

### Card Comm menu 4-5

### Card Failure

- System State Alarm 4-4

### C-Bit Coding Violations (CCV) 5-8

### C-Bit Errored Seconds (CES) 5-8

### C-bit parity

- remote loopback 6-4

### C-Bit Severely Errored Seconds (CSES) 5-8

### Charger Fail, Power Supply State 4-4

### circuit protection mode 4-5

### Clear All Local DS3 Statistics 5-9

### Clear All T1/E1 Alarm Counts 5-13

### clearing statistics 5-9

### codec line/net loopback 6-4

### Common Eqpt Fail (NSA) Remote status 4-3

### Configuration menus

- Network Interface 3-4
- Save Configuration 3-44
- Utilities 3-38

### Connection Timeout menu 3-20

- 
- Controller Traps 3-22
  - craft port pin assignments B-1
  - CSU Loopback 6-4
  - CSU Loopback w/BERT 6-4
  - D**
  - data link state 4-2
  - data mode 6-9
  - Date & Time menu 3-33
  - date, setting 3-33
  - Dial String menu 3-19
  - Dialout On Trap menu 3-20
  - digital line/net loopback 6-3
  - digital loopback 6-7
  - DS1 Eqpt Fail (NSA) 4-3
  - DS1 Eqpt Fail (SA), Remote status 4-3
  - DS2 Configuration menu 3-7
  - DS2 State
    - AIS 4-6
    - LOF 4-6
    - OK 4-6
    - RAI 4-6
  - DS2 Statistics menu 5-9
  - DS3 Configuration menu 3-4
  - DS3 Eqpt Fail (NSA) 4-3
  - DS3 Eqpt Fail (SA) 4-3
  - DS3 Loopbacks 6-6
  - DS3 State
    - Alarm 4-2
    - In Test 4-2
    - Normal 4-2
  - DS3 State menu 4-1
  - DS3 Statistics menu 5-2
  - DSX-1/E1 interfaces, rear panel 2-8
  - DSX-3 interfaces, rear panel 2-7
  - E**
  - Equipment Code menu 3-37
  - error codes 9-17
  - Error, Power Supply State 4-4
  - establishing a terminal connection 2-9
  - Excessive CV, State 4-2
  - Excessive Switches, System State Alarm 4-4
  - F**
  - Facility ID menu 3-36
  - Failure, Card A/Card B 4-5
  - fan faceplate, overview 1-4
  - Far End Block Errors (FEBE) 5-9
  - F-Bit Errors (FBE) 5-8
  - FEAC 6-4
  - Frame ID menu 3-36
  - G**
  - Gateway IP Address menu 3-17
  - H**
  - Hangup menu 3-21
  - Host Facility menu 3-37
  - Host IP Address menu 3-37
  - HOT, T1/E1 State 4-6
  - I**
  - Idle
    - 24 Hour Alarm History (DS3 statistics) 5-3
    - Remote status 4-3
    - State 4-2
  - Idle Timeout menu 3-19
  - In Test, DS3 State 4-2
  - informational events 9-11
  - Initializing String menu 3-19
  - Interval starting at:, Performance Parameters (DS3) 5-7
  - IP address trap 3-21
  - IP Hosts menu 3-33
  - IP Security menu 3-33
  - L**
  - LAIS
    - T1/E1 State 4-6
  - LAN pin assignments B-1
  - LAN port, MX2800 2-7
  - Last Modem Response menu 3-21
  - LEDs
    - ACT, active cards 2-16
    - ACT, standby cards 2-17
    - ALM, active cards 2-16
    - ALM, standby cards 2-17
    - NET, active cards 2-16
    - NET, standby cards 2-17
    - PRF, active cards 2-16
    - PRF, standby cards 2-17
  - Line BERT 6-5
  - Line Coding menus, T1/E1 3-10
  - Line Coding Violation (LCV) 5-8
  - Line Coding Violations (LCV) 5-8
  - Line Errored Seconds (LES) 5-8
  - Line Length menu
    - long 3-4
    - short 3-4
  - Line Length menus, T1/E1 3-11

- Line Loopback 6-7
- Local IP Address menu 3-17
- Location ID menu 3-36
- LOF
  - 24 Hour Alarm History (DS3 statistics) 5-2
  - DS2 State 4-6
  - State 4-2
- logging out 2-15
- long line length 3-4
- loopback
  - CSU 6-4
  - CSU with BERT 6-4
  - DS2 6-9
  - DS3 6-6
  - T1/E1 6-2
- Loopback menu
  - Analog Network 6-3
  - Codec Line/Net 6-4
  - CSU Loopback 6-4
  - CSU Loopback w/BERT 6-4
  - Digital Line/Net 6-3
  - Digital Loopback 6-7
  - DS2 Loopback 6-9
  - DS2 Network 6-9
  - DS3 Loopbacks 6-6
  - Line BERT 6-5
  - Line Loopback 6-7
  - Metallic Loopback 6-8
  - Remote all T1/E1 6-8
  - Remote Loopback 6-4, 6-8
  - T1/E1 Loopbacks 6-2
  - Tributary 6-2
- Loopback menu, network configuration 3-7
- LOS
  - 24 Hour Alarm History (DS3 statistics) 5-2
  - Remote status 4-3
  - State 4-2
  - T1/E1 State 4-6
- Loss of Signal Alarms 5-13
- M**
  - management station addresses 3-33
  - Maximum Redial Attempts menu 3-19
  - menu navigation 2-10
  - metallic loopback 6-8
  - MIB, SNMP 1-3
  - Miscellaneous menu 3-33
  - Miscellaneous menus, network configuration 3-7
  - Modem Mode menu 3-20
  - Modem port, MX2800 2-7
  - Multiple DS1 LOS, Remote status 4-3
  - MX2800 options 1-3
  - MX2800 Product Overview 1-1
- N**
  - navigating the menus 2-10
  - NET LED, active cards 2-16
  - NET LED, standby cards 2-17
  - Network Interface menus 3-4
  - network manager, SNMP 1-2
  - network protection mode 4-5
  - none, Protection mode 4-5
  - non-redundant power mode 8-1
- Normal
  - Power Supply State 4-4
  - Remote status 4-3
- Not Installed, Card A/Card B 4-5
- O**
  - OK
    - DS2 State 4-6
    - T1/E1 state 4-6
  - OOF
    - Remote status 4-3
  - options for the MX2800 1-3
  - output response messages 9-4
- P**
  - Pause Between Calls menu 3-20
  - P-Bit Coding Violations (PCV) 5-8
  - P-Bit Errored Seconds (CES) 5-8
  - P-Bit Severely Errored Seconds (CSES) 5-8
  - Performance Parameters (DS3)
    - C-Bit Coding Violations (CCV) 5-8
    - C-Bit Errored Seconds (CES) 5-8
    - C-Bit Severely Errored Seconds (CSES) 5-8
    - Clear All Local DS3 Statistics 5-9
    - Far End Block Errors (FEBE) 5-9
    - F-Bit Errors (FBE) 5-8
    - Interval starting at: 5-7
    - Line Coding Violation (LCV) 5-8
    - Line Coding Violations (LCV) 5-8
    - Line Errored Seconds (LES) 5-8
    - P-Bit Coding Violations (PCV) 5-8
    - P-Bit Errored Seconds (CES) 5-8
    - P-Bit Severely Errored Seconds (CSES) 5-8
    - Refresh All Remote Statistics 5-9
    - Severely Errored Framing Seconds (SEFS) 5-8
    - Unavailable Seconds (UAS) 5-8

Performance Parameters menu (DS2) 5-11  
 Performance Parameters menu (DS3) 5-4  
 phone numbers  
   primary 3-19  
   secondary 3-19  
 pin assignments  
   auxiliary port B-1  
   control connector B-1  
   craft port B-1  
   LAN B-1  
   LAN port B-1  
 pinouts A-1, B-1  
 power connection, rear panel 2-8  
 Power Fail, Power Supply State 4-4  
 power loss recovery  
   non-redundant power mode 8-1  
   power supply and source recovery mode 8-2  
   power supply recovery mode 8-2  
 Power Low  
   Power Supply State 4-4  
 power supply and source recovery mode 8-2  
 power supply recovery mode 8-2  
 Power Supply State  
   Battery Low 4-4  
   Charger Fail 4-4  
   Error 4-4  
   Normal 4-4  
   Power Fail 4-4  
   Power Low 4-4  
   Temp Critical 4-4  
   Temp High 4-4  
 Power Supply State menu 4-4  
 power up  
   AC version 2-2  
   DC version 2-2  
 PRF LED, active cards 2-16  
 PRF LED, standby cards 2-17  
 Privilege Level 2-15  
 Protection Configuration menus 3-6  
 Protection menu 4-5  
 protection mode  
   Circuit 4-5  
   circuit failure recovery 7-2, 7-3  
   Network 4-5  
   network failure recovery 7-3  
   None 4-5  
   non-redundant 7-1  
 Protection Threshold 3-14

**R**

RAI  
   24 Hour Alarm History (DS3 statistics) 5-2  
   DS2 State 4-6  
   Remote status 4-3  
   State 4-2  
 Read Community Name 3-24  
 Read Community Name address 3-21  
 receiving inspection 2-1  
 redundancy  
   circuit and network failure recovery mode 7-3  
   circuit failure recovery mode 7-2  
   non-redundant mode 7-1  
 Refresh All Remote Statistics 5-9  
 refreshing remote statistics 5-9  
 remote loopback  
   DS3 6-8  
   T1/E1 6-4  
 Remote Loopbacks menu 3-5  
 Remote menu 4-3  
 Remote state  
   unknown 4-3  
 Remote status  
   AIS 4-3  
   Common Eqpt Fail (NSA) 4-3  
   DS1 Eqpt Fail (NSA) 4-3  
   DS1 Eqpt Fail (SA) 4-3  
   DS3 Eqpt Fail (NSA) 4-3  
   DS3 Eqpt Fail (SA) 4-3  
   Idle 4-3  
   LOF 4-3  
   LOS 4-3  
   Multiple DS1 LOS 4-3  
   Normal 4-3  
   RAI 4-3  
   Single DS1 LOS 4-3  
 resetting the system 3-43  
 Rx Framing menu 4-1

**S**

Save Configuration and Alarm Log menu 3-44  
 setting the baud rate 3-20  
 setting the date 3-33  
 setting the time 3-33  
 Severely Errored Framing Seconds (SEFS) 5-8  
 Severity Level menu 3-37  
 shipping, contents 2-1  
 short line length 3-4  
 Single DS1 LOS, Remote status 4-3

- 
- SNMP Management Options 3-21
  - SNMP State 3-21
  - SNMP State menu 3-21
  - SNMP, overview 1-2
  - specifications, MX2800 C-1
  - Stand By, Card A/Card B 4-5
  - State menu (DS3 State) 4-2
  - State menus, T1/E1 3-9
  - Statistics menu
    - 24 Hour Alarm History (DS2) 5-9
    - 24 Hour Alarm History (DS3) 5-2
    - Clear All T1/E1 Alarm Counts 5-13
    - DS2 Statistics 5-9
    - DS3 Statistics 5-2
    - Performance Parameters (DS3) 5-4
    - T1/E1 Statistics 5-13
  - Statistics menus 5-1
  - Status menu
    - Alarm (DS3 State) 4-2
    - Alarm (System State) 4-4
    - Card A/Card B 4-5
    - Card Comm 4-5
    - DS2 State 4-6
    - DS3 State 4-1
    - Power Supply State 4-4
    - Protection 4-5
    - Remote 4-3
    - Rx Framing 4-1
    - State 4-2
    - System State 4-4
  - Subnet Mask menu 3-17
  - Supply Failure, System State Alarm 4-4
  - Switched, System State Alarm 4-4
  - Syslog Setup menu 3-37
  - system alarms 3-34
  - System Name 3-25
  - system reset 3-43
  - System Security 3-26
  - System Security menu 3-26
  - System State Alarm
    - Card Failure 4-4
    - Excessive Switches 4-4
    - Supply Failure 4-4
    - Switched 4-4
  - System State menu 4-4
  - T**
  - T1/E1 Line Length menu 3-11
  - T1/E1 menus
    - Line Coding 3-10
    - State 3-9
  - T1/E1 State
    - CAIS 4-6
    - HOT 4-6
    - LAIS 4-6
    - LOS 4-6
    - OK 4-6
    - TST 4-6
    - XCV 4-6
  - T1/E1 Statistics menu 5-13
  - Telnet, overview 1-3
  - Temp Critical, Power Supply State 4-4
  - Temp High, Power Supply State 4-4
  - terminal connection, establishing 2-9
  - time, setting 3-33
  - TL1
    - alarm events 9-11
    - autonomous messages 9-11
    - commands 9-5
    - Editing 9-17
    - error codes 9-17
    - informational events 9-11
    - messages 9-3
    - responses 9-3
  - TLOS, State 4-2
  - Transmission menu 3-37
  - Trap Community Name 3-25
  - Trap Generation menu 3-21
  - Trap IP Addresses menu 3-21
  - traps
    - controller 3-22
    - for calls between primary and secondary numbers 3-19
    - for redialing 3-19
  - Tributary loopback 6-2
  - TST, T1/E1 State 4-6
  - U**
  - Unavailable Seconds (UAS) 5-8
  - Unit ID Code menu 3-36
  - Unknown, Remote state 4-3
  - Utilities menu 3-38
  - V**
  - viewing statistical information 5-1
  - W**
  - Write Community Name 3-25

**X**

XCV

T1/E1 State 4-6

## Notes

**ADURAN**